

R&S®OSP

Open Switch and Control Unit

Quick Start Guide



1505.3896.62 – 12

- The Quick Start Guide describes the following R&S®OSP models and options:
- R&S®OSP120, stock no. 1505.3009.02/.12
- R&S®OSP130, stock no. 1505.3009.03
- R&S®OSP150, stock no. 1505.3009.05/.15
- Option Module R&S®OSP-B011, stock no. 1505.4763.02
- Option Module R&S®OSP-B012, stock no. 1505.4770.02
- Option Module R&S®OSP-B101, stock no. 1505.5101.02
- Option Module R&S®OSP-B101L, stock no. 1505.5101.52
- Option Module R&S®OSP-B102, stock no. 1505.5201.02
- Option Module R&S®OSP-B102L, stock no. 1505.5201.52
- Option Module R&S®OSP-B103, stock no. 1505.5301.02
- Option Module R&S®OSP-B104, stock no. 1505.5401.02
- Option Module R&S®OSP-B106, stock no. 1505.5601.02
- Option Module R&S®OSP-B107, stock no. 1505.5901.02
- Option Module R&S®OSP-B108, stock no. 1505.5718.02
- Option Module R&S®OSP-B111, stock no. 1505.4605.02
- Option Module R&S®OSP-B112, stock no. 1505.4611.02
- Option Module R&S®OSP-B114, stock no. 1505.4711.02
- Option Module R&S®OSP-B116, stock no. 1515.5827.02
- Option Module R&S®OSP-B119, stock no. 1515.5856.02
- Option Module R&S®OSP-B121, stock no. 1515.5504.02
- Option Module R&S®OSP-B121H, stock no. 1515.5504.40
- Option Module R&S®OSP-B122, stock no. 1515.5510.02
- Option Module R&S®OSP-B123, stock no. 1515.5527.02
- Option Module R&S®OSP-B124, stock no. 1515.5533.02
- Option Module R&S®OSP-B125, stock no. 1515.5540.02
- Option Module R&S®OSP-B126, stock no. 1515.5556.02
- Option Module R&S®OSP-B127, stock no. 1505.4728.02
- Option Module R&S®OSP-B128, stock no. 1505.4734.02
- Option Module R&S®OSP-B129, stock no. 1515.5556.02
- Option Module R&S®OSP-B131, stock no. 1505.4740.02
- Option Module R&S®OSP-B132, stock no. 1505.4757.02
- Option Module R&S®OSP-B136, stock no. 1522.4500.02
- Option Module R&S®OSP-B142, stock no. 1528.1048.03/.11/.12/.13
- Option Module R&S®OSP-B158, stock no. 4094.7300.02

The firmware of the instrument makes use of the operating system LINUX® and other valuable open source software packages. For information, see the "Open Source Acknowledgement" on the user documentation CD-ROM (included in delivery) or at <https://www.rohde-schwarz.com/en/firmware/osp>.

Rohde & Schwarz would like to thank the open source community for their valuable contribution to embedded computing.

© 2015 Rohde & Schwarz GmbH & Co. KG

Muehldorfstr. 15, 81671 Munich, Germany

Phone: +49 89 41 29 - 0

Fax: +49 89 41 29 12 164

E-mail: info@rohde-schwarz.com

Internet: <http://www.rohde-schwarz.com>

Subject to change – Data without tolerance limits is not binding.

R&S® is a registered trademark of Rohde & Schwarz GmbH & Co. KG.

Trade names are trademarks of the owners.

The following abbreviations are used throughout this manual:

R&S®OSP is abbreviated as R&S OSP

Basic Safety Instructions

Always read through and comply with the following safety instructions!

All plants and locations of the Rohde & Schwarz group of companies make every effort to keep the safety standards of our products up to date and to offer our customers the highest possible degree of safety. Our products and the auxiliary equipment they require are designed, built and tested in accordance with the safety standards that apply in each case. Compliance with these standards is continuously monitored by our quality assurance system. The product described here has been designed, built and tested in accordance with the EC Certificate of Conformity and has left the manufacturer's plant in a condition fully complying with safety standards. To maintain this condition and to ensure safe operation, you must observe all instructions and warnings provided in this manual. If you have any questions regarding these safety instructions, the Rohde & Schwarz group of companies will be happy to answer them.



Furthermore, it is your responsibility to use the product in an appropriate manner. This product is designed for use solely in industrial and laboratory environments or, if expressly permitted, also in the field and must not be used in any way that may cause personal injury or property damage. You are responsible if the product is used for any purpose other than its designated purpose or in disregard of the manufacturer's instructions. The manufacturer shall assume no responsibility for such use of the product.

The product is used for its designated purpose if it is used in accordance with its product documentation and within its performance limits (see data sheet, documentation, the following safety instructions). Using the product requires technical skills and, in some cases, a basic knowledge of English. It is therefore essential that only skilled and specialized staff or thoroughly trained personnel with the required skills be allowed to use the product. If personal safety gear is required for using Rohde & Schwarz products, this will be indicated at the appropriate place in the product documentation. Keep the basic safety instructions and the product documentation in a safe place and pass them on to the subsequent users.











Observing the safety instructions will help prevent personal injury or damage of any kind caused by dangerous situations. Therefore, carefully read through and adhere to the following safety instructions before and when using the product. It is also absolutely essential to observe the additional safety instructions on personal safety, for example, that appear in relevant parts of the product documentation. In these safety instructions, the word "product" refers to all merchandise sold and distributed by the Rohde & Schwarz group of companies, including instruments, systems and all accessories. For product-specific information, see the data sheet and the product documentation.

Safety labels on products

The following safety labels are used on products to warn against risks and dangers.

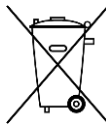
Symbol	Meaning	Symbol	Meaning
	Notice, general danger location Observe product documentation	○	ON/OFF Power
	Caution when handling heavy equipment	⏻	Standby indication
	Danger of electric shock	≡	Direct current (DC)

Basic Safety Instructions

Symbol	Meaning	Symbol	Meaning
	Caution ! Hot surface		Alternating current (AC)
	Protective conductor terminal To identify any terminal which is intended for connection to an external conductor for protection against electric shock in case of a fault, or the terminal of a protective earth		Direct/alternating current (DC/AC)
	Earth (Ground)		Class II Equipment to identify equipment meeting the safety requirements specified for Class II equipment (device protected by double or reinforced insulation)
	Frame or chassis Ground terminal		EU labeling for batteries and accumulators For additional information, see section "Waste disposal/Environmental protection", item 1.
	Be careful when handling electrostatic sensitive devices		EU labeling for separate collection of electrical and electronic devices For additional information, see section "Waste disposal/Environmental protection", item 2.
	Warning! Laser radiation For additional information, see section "Operation", item 7.		

Signal words and their meaning

The following signal words are used in the product documentation in order to warn the reader about risks and dangers.



Indicates a hazardous situation which, if not avoided, will result in death or serious injury.



Indicates a hazardous situation which, if not avoided, could result in death or serious injury.



Indicates a hazardous situation which, if not avoided, could result in minor or moderate injury.



Indicates information considered important, but not hazard-related, e.g. messages relating to property damage.

In the product documentation, the word ATTENTION is used synonymously.

These signal words are in accordance with the standard definition for civil applications in the European Economic Area. Definitions that deviate from the standard definition may also exist in other economic areas or military applications. It is therefore essential to make sure that the signal words described here are always used only in connection with the related product documentation and the related product. The use of signal words in connection with unrelated products or documentation can result in misinterpretation and in personal injury or material damage.

Basic Safety Instructions

Operating states and operating positions

The product may be operated only under the operating conditions and in the positions specified by the manufacturer, without the product's ventilation being obstructed. If the manufacturer's specifications are not observed, this can result in electric shock, fire and/or serious personal injury or death. Applicable local or national safety regulations and rules for the prevention of accidents must be observed in all work performed.

1. Unless otherwise specified, the following requirements apply to Rohde & Schwarz products: predefined operating position is always with the housing floor facing down, IP protection 2X, use only indoors, max. operating altitude 2000 m above sea level, max. transport altitude 4500 m above sea level. A tolerance of $\pm 10\%$ shall apply to the nominal voltage and $\pm 5\%$ to the nominal frequency, overvoltage category 2, pollution degree 2.
2. Do not place the product on surfaces, vehicles, cabinets or tables that for reasons of weight or stability are unsuitable for this purpose. Always follow the manufacturer's installation instructions when installing the product and fastening it to objects or structures (e.g. walls and shelves). An installation that is not carried out as described in the product documentation could result in personal injury or even death.
3. Do not place the product on heat-generating devices such as radiators or fan heaters. The ambient temperature must not exceed the maximum temperature specified in the product documentation or in the data sheet. Product overheating can cause electric shock, fire and/or serious personal injury or even death.

Electrical safety

If the information on electrical safety is not observed either at all or to the extent necessary, electric shock, fire and/or serious personal injury or death may occur.

1. Prior to switching on the product, always ensure that the nominal voltage setting on the product matches the nominal voltage of the mains-supply network. If a different voltage is to be set, the power fuse of the product may have to be changed accordingly.
2. In the case of products of safety class I with movable power cord and connector, operation is permitted only on sockets with a protective conductor contact and protective conductor.
3. Intentionally breaking the protective conductor either in the feed line or in the product itself is not permitted. Doing so can result in the danger of an electric shock from the product. If extension cords or connector strips are implemented, they must be checked on a regular basis to ensure that they are safe to use.
4. If there is no power switch for disconnecting the product from the mains, or if the power switch is not suitable for this purpose, use the plug of the connecting cable to disconnect the product from the mains. In such cases, always ensure that the power plug is easily reachable and accessible at all times. For example, if the power plug is the disconnecting device, the length of the connecting cable must not exceed 3 m. Functional or electronic switches are not suitable for providing disconnection from the AC supply network. If products without power switches are integrated into racks or systems, the disconnecting device must be provided at the system level.
5. Never use the product if the power cable is damaged. Check the power cables on a regular basis to ensure that they are in proper operating condition. By taking appropriate safety measures and carefully laying the power cable, ensure that the cable cannot be damaged and that no one can be hurt by, for example, tripping over the cable or suffering an electric shock.

Basic Safety Instructions

6. The product may be operated only from TN/TT supply networks fuse-protected with max. 16 A (higher fuse only after consulting with the Rohde & Schwarz group of companies).
7. Do not insert the plug into sockets that are dusty or dirty. Insert the plug firmly and all the way into the socket provided for this purpose. Otherwise, sparks that result in fire and/or injuries may occur.
8. Do not overload any sockets, extension cords or connector strips; doing so can cause fire or electric shocks.
9. For measurements in circuits with voltages $V_{rms} > 30$ V, suitable measures (e.g. appropriate measuring equipment, fuse protection, current limiting, electrical separation, insulation) should be taken to avoid any hazards.
10. Ensure that the connections with information technology equipment, e.g. PCs or other industrial computers, comply with the IEC 60950-1 / EN 60950-1 or IEC 61010-1 / EN 61010-1 standards that apply in each case.
11. Unless expressly permitted, never remove the cover or any part of the housing while the product is in operation. Doing so will expose circuits and components and can lead to injuries, fire or damage to the product.
12. If a product is to be permanently installed, the connection between the protective conductor terminal on site and the product's protective conductor must be made first before any other connection is made. The product may be installed and connected only by a licensed electrician.
13. For permanently installed equipment without built-in fuses, circuit breakers or similar protective devices, the supply circuit must be fuse-protected in such a way that anyone who has access to the product, as well as the product itself, is adequately protected from injury or damage.
14. Use suitable overvoltage protection to ensure that no overvoltage (such as that caused by a bolt of lightning) can reach the product. Otherwise, the person operating the product will be exposed to the danger of an electric shock.
15. Any object that is not designed to be placed in the openings of the housing must not be used for this purpose. Doing so can cause short circuits inside the product and/or electric shocks, fire or injuries.
16. Unless specified otherwise, products are not liquid-proof (see also section "Operating states and operating positions", item 1). Therefore, the equipment must be protected against penetration by liquids. If the necessary precautions are not taken, the user may suffer electric shock or the product itself may be damaged, which can also lead to personal injury.
17. Never use the product under conditions in which condensation has formed or can form in or on the product, e.g. if the product has been moved from a cold to a warm environment. Penetration by water increases the risk of electric shock.
18. Prior to cleaning the product, disconnect it completely from the power supply (e.g. AC supply network or battery). Use a soft, non-linting cloth to clean the product. Never use chemical cleaning agents such as alcohol, acetone or diluents for cellulose lacquers.

Operation

1. Operating the products requires special training and intense concentration. Make sure that persons who use the products are physically, mentally and emotionally fit enough to do so; otherwise, injuries or material damage may occur. It is the responsibility of the employer/operator to select suitable personnel for operating the products.

Basic Safety Instructions

2. Before you move or transport the product, read and observe the section titled "Transport".
3. As with all industrially manufactured goods, the use of substances that induce an allergic reaction (allergens) such as nickel cannot be generally excluded. If you develop an allergic reaction (such as a skin rash, frequent sneezing, red eyes or respiratory difficulties) when using a Rohde & Schwarz product, consult a physician immediately to determine the cause and to prevent health problems or stress.
4. Before you start processing the product mechanically and/or thermally, or before you take it apart, be sure to read and pay special attention to the section titled "Waste disposal/Environmental protection", item 1.
5. Depending on the function, certain products such as RF radio equipment can produce an elevated level of electromagnetic radiation. Considering that unborn babies require increased protection, pregnant women must be protected by appropriate measures. Persons with pacemakers may also be exposed to risks from electromagnetic radiation. The employer/operator must evaluate workplaces where there is a special risk of exposure to radiation and, if necessary, take measures to avert the potential danger.
6. Should a fire occur, the product may release hazardous substances (gases, fluids, etc.) that can cause health problems. Therefore, suitable measures must be taken, e.g. protective masks and protective clothing must be worn.
7. Laser products are given warning labels that are standardized according to their laser class. Lasers can cause biological harm due to the properties of their radiation and due to their extremely concentrated electromagnetic power. If a laser product (e.g. a CD/DVD drive) is integrated into a Rohde & Schwarz product, absolutely no other settings or functions may be used as described in the product documentation. The objective is to prevent personal injury (e.g. due to laser beams).
8. EMC classes (in line with EN 55011/CISPR 11, and analogously with EN 55022/CISPR 22, EN 55032/CISPR 32)
 - Class A equipment:
Equipment suitable for use in all environments except residential environments and environments that are directly connected to a low-voltage supply network that supplies residential buildings
Note: Class A equipment is intended for use in an industrial environment. This equipment may cause radio disturbances in residential environments, due to possible conducted as well as radiated disturbances. In this case, the operator may be required to take appropriate measures to eliminate these disturbances.
 - Class B equipment:
Equipment suitable for use in residential environments and environments that are directly connected to a low-voltage supply network that supplies residential buildings

Repair and service

1. The product may be opened only by authorized, specially trained personnel. Before any work is performed on the product or before the product is opened, it must be disconnected from the AC supply network. Otherwise, personnel will be exposed to the risk of an electric shock.

Basic Safety Instructions

2. Adjustments, replacement of parts, maintenance and repair may be performed only by electrical experts authorized by Rohde & Schwarz. Only original parts may be used for replacing parts relevant to safety (e.g. power switches, power transformers, fuses). A safety test must always be performed after parts relevant to safety have been replaced (visual inspection, protective conductor test, insulation resistance measurement, leakage current measurement, functional test). This helps ensure the continued safety of the product.

Batteries and rechargeable batteries/cells

If the information regarding batteries and rechargeable batteries/cells is not observed either at all or to the extent necessary, product users may be exposed to the risk of explosions, fire and/or serious personal injury, and, in some cases, death. Batteries and rechargeable batteries with alkaline electrolytes (e.g. lithium cells) must be handled in accordance with the EN 62133 standard.

1. Cells must not be taken apart or crushed.
2. Cells or batteries must not be exposed to heat or fire. Storage in direct sunlight must be avoided. Keep cells and batteries clean and dry. Clean soiled connectors using a dry, clean cloth.
3. Cells or batteries must not be short-circuited. Cells or batteries must not be stored in a box or in a drawer where they can short-circuit each other, or where they can be short-circuited by other conductive materials. Cells and batteries must not be removed from their original packaging until they are ready to be used.
4. Cells and batteries must not be exposed to any mechanical shocks that are stronger than permitted.
5. If a cell develops a leak, the fluid must not be allowed to come into contact with the skin or eyes. If contact occurs, wash the affected area with plenty of water and seek medical aid.
6. Improperly replacing or charging cells or batteries that contain alkaline electrolytes (e.g. lithium cells) can cause explosions. Replace cells or batteries only with the matching Rohde & Schwarz type (see parts list) in order to ensure the safety of the product.
7. Cells and batteries must be recycled and kept separate from residual waste. Rechargeable batteries and normal batteries that contain lead, mercury or cadmium are hazardous waste. Observe the national regulations regarding waste disposal and recycling.

Transport

1. The product may be very heavy. Therefore, the product must be handled with care. In some cases, the user may require a suitable means of lifting or moving the product (e.g. with a lift-truck) to avoid back or other physical injuries.
2. Handles on the products are designed exclusively to enable personnel to transport the product. It is therefore not permissible to use handles to fasten the product to or on transport equipment such as cranes, fork lifts, wagons, etc. The user is responsible for securely fastening the products to or on the means of transport or lifting. Observe the safety regulations of the manufacturer of the means of transport or lifting. Noncompliance can result in personal injury or material damage.
3. If you use the product in a vehicle, it is the sole responsibility of the driver to drive the vehicle safely and properly. The manufacturer assumes no responsibility for accidents or collisions. Never use the product in a moving vehicle if doing so could distract the driver of the vehicle. Adequately secure the product in the vehicle to prevent injuries or other damage in the event of an accident.

Instrucciones de seguridad elementales

Waste disposal/Environmental protection

1. Specially marked equipment has a battery or accumulator that must not be disposed of with unsorted municipal waste, but must be collected separately. It may only be disposed of at a suitable collection point or via a Rohde & Schwarz customer service center.
2. Waste electrical and electronic equipment must not be disposed of with unsorted municipal waste, but must be collected separately.
Rohde & Schwarz GmbH & Co. KG has developed a disposal concept and takes full responsibility for take-back obligations and disposal obligations for manufacturers within the EU. Contact your Rohde & Schwarz customer service center for environmentally responsible disposal of the product.
3. If products or their components are mechanically and/or thermally processed in a manner that goes beyond their intended use, hazardous substances (heavy-metal dust such as lead, beryllium, nickel) may be released. For this reason, the product may only be disassembled by specially trained personnel. Improper disassembly may be hazardous to your health. National waste disposal regulations must be observed.
4. If handling the product releases hazardous substances or fuels that must be disposed of in a special way, e.g. coolants or engine oils that must be replenished regularly, the safety instructions of the manufacturer of the hazardous substances or fuels and the applicable regional waste disposal regulations must be observed. Also observe the relevant safety instructions in the product documentation. The improper disposal of hazardous substances or fuels can cause health problems and lead to environmental damage.

For additional information about environmental protection, visit the Rohde & Schwarz website.

Instrucciones de seguridad elementales

¡Es imprescindible leer y cumplir las siguientes instrucciones e informaciones de seguridad!

El principio del grupo de empresas Rohde & Schwarz consiste en tener nuestros productos siempre al día con los estándares de seguridad y de ofrecer a nuestros clientes el máximo grado de seguridad. Nuestros productos y todos los equipos adicionales son siempre fabricados y examinados según las normas de seguridad vigentes. Nuestro sistema de garantía de calidad controla constantemente que sean cumplidas estas normas. El presente producto ha sido fabricado y examinado según el certificado de conformidad de la UE y ha salido de nuestra planta en estado impecable según los estándares técnicos de seguridad. Para poder preservar este estado y garantizar un funcionamiento libre de peligros, el usuario deberá atenerse a todas las indicaciones, informaciones de seguridad y notas de alerta. El grupo de empresas Rohde & Schwarz está siempre a su disposición en caso de que tengan preguntas referentes a estas informaciones de seguridad.

Además queda en la responsabilidad del usuario utilizar el producto en la forma debida. Este producto está destinado exclusivamente al uso en la industria y el laboratorio o, si ha sido expresamente autorizado, para aplicaciones de campo y de ninguna manera deberá ser utilizado de modo que alguna persona/cosa pueda sufrir daño. El uso del producto fuera de sus fines definidos o sin tener en cuenta las instrucciones del fabricante queda en la responsabilidad del usuario. El fabricante no se hace en ninguna forma responsable de consecuencias a causa del mal uso del producto.















Instrucciones de seguridad elementales

Se parte del uso correcto del producto para los fines definidos si el producto es utilizado conforme a las indicaciones de la correspondiente documentación del producto y dentro del margen de rendimiento definido (ver hoja de datos, documentación, informaciones de seguridad que siguen). El uso del producto hace necesarios conocimientos técnicos y ciertos conocimientos del idioma inglés. Por eso se debe tener en cuenta que el producto solo pueda ser operado por personal especializado o personas instruidas en profundidad con las capacidades correspondientes. Si fuera necesaria indumentaria de seguridad para el uso de productos de Rohde & Schwarz, encontraría la información debida en la documentación del producto en el capítulo correspondiente. Guarde bien las informaciones de seguridad elementales, así como la documentación del producto, y entréguelas a usuarios posteriores.



Tener en cuenta las informaciones de seguridad sirve para evitar en lo posible lesiones o daños por peligros de toda clase. Por eso es imprescindible leer detalladamente y comprender por completo las siguientes informaciones de seguridad antes de usar el producto, y respetarlas durante el uso del producto. Deberán tenerse en cuenta todas las demás informaciones de seguridad, como p. ej. las referentes a la protección de personas, que encontrarán en el capítulo correspondiente de la documentación del producto y que también son de obligado cumplimiento. En las presentes informaciones de seguridad se recogen todos los objetos que distribuye el grupo de empresas Rohde & Schwarz bajo la denominación de "producto", entre ellos también aparatos, instalaciones así como toda clase de accesorios. Los datos específicos del producto figuran en la hoja de datos y en la documentación del producto.

Señalización de seguridad de los productos

Las siguientes señales de seguridad se utilizan en los productos para advertir sobre riesgos y peligros.

Símbolo	Significado	Símbolo	Significado
	Aviso: punto de peligro general Observar la documentación del producto		Tensión de alimentación de PUESTA EN MARCHA / PARADA
	Atención en el manejo de dispositivos de peso elevado		Indicación de estado de espera (standby)
	Peligro de choque eléctrico		Corriente continua (DC)
	Advertencia: superficie caliente		Corriente alterna (AC)
	Conexión a conductor de protección		Corriente continua / Corriente alterna (DC/AC)
	Conexión a tierra		El aparato está protegido en su totalidad por un aislamiento doble (reforzado)
	Conexión a masa		Distintivo de la UE para baterías y acumuladores Más información en la sección "Eliminación/protección del medio ambiente", punto 1.

Instrucciones de seguridad elementales

Símbolo	Significado	Símbolo	Significado
	Aviso: Cuidado en el manejo de dispositivos sensibles a la electrostática (ESD)		Distintivo de la UE para la eliminación por separado de dispositivos eléctricos y electrónicos Más información en la sección "Eliminación/protección del medio ambiente", punto 2.
	Advertencia: rayo láser Más información en la sección "Funcionamiento", punto 7.		

Palabras de señal y su significado

En la documentación del producto se utilizan las siguientes palabras de señal con el fin de advertir contra riesgos y peligros.



Indica una situación de peligro que, si no se evita, causa lesiones graves o incluso la muerte.



Indica una situación de peligro que, si no se evita, puede causar lesiones graves o incluso la muerte.



Indica una situación de peligro que, si no se evita, puede causar lesiones leves o moderadas.



Indica información que se considera importante, pero no en relación con situaciones de peligro; p. ej., avisos sobre posibles daños materiales.

En la documentación del producto se emplea de forma sinónima el término CUIDADO.

Las palabras de señal corresponden a la definición habitual para aplicaciones civiles en el área económica europea. Pueden existir definiciones diferentes a esta definición en otras áreas económicas o en aplicaciones militares. Por eso se deberá tener en cuenta que las palabras de señal aquí descritas sean utilizadas siempre solamente en combinación con la correspondiente documentación del producto y solamente en combinación con el producto correspondiente. La utilización de las palabras de señal en combinación con productos o documentaciones que no les correspondan puede llevar a interpretaciones equivocadas y tener por consecuencia daños en personas u objetos.

Estados operativos y posiciones de funcionamiento

El producto solamente debe ser utilizado según lo indicado por el fabricante respecto a los estados operativos y posiciones de funcionamiento sin que se obstruya la ventilación. Si no se siguen las indicaciones del fabricante, pueden producirse choques eléctricos, incendios y/o lesiones graves con posible consecuencia de muerte. En todos los trabajos deberán ser tenidas en cuenta las normas nacionales y locales de seguridad del trabajo y de prevención de accidentes.

Instrucciones de seguridad elementales

1. Si no se convino de otra manera, es para los productos Rohde & Schwarz válido lo que sigue: como posición de funcionamiento se define por principio la posición con el suelo de la caja para abajo, modo de protección IP 2X, uso solamente en estancias interiores, utilización hasta 2000 m sobre el nivel del mar, transporte hasta 4500 m sobre el nivel del mar. Se aplicará una tolerancia de $\pm 10\%$ sobre el voltaje nominal y de $\pm 5\%$ sobre la frecuencia nominal. Categoría de sobrecarga eléctrica 2, índice de suciedad 2.
2. No sitúe el producto encima de superficies, vehículos, estantes o mesas, que por sus características de peso o de estabilidad no sean aptos para él. Siga siempre las instrucciones de instalación del fabricante cuando instale y asegure el producto en objetos o estructuras (p. ej. paredes y estantes). Si se realiza la instalación de modo distinto al indicado en la documentación del producto, se pueden causar lesiones o, en determinadas circunstancias, incluso la muerte.
3. No ponga el producto sobre aparatos que generen calor (p. ej. radiadores o calefactores). La temperatura ambiente no debe superar la temperatura máxima especificada en la documentación del producto o en la hoja de datos. En caso de sobrecalentamiento del producto, pueden producirse choques eléctricos, incendios y/o lesiones graves con posible consecuencia de muerte.

Seguridad eléctrica

Si no se siguen (o se siguen de modo insuficiente) las indicaciones del fabricante en cuanto a seguridad eléctrica, pueden producirse choques eléctricos, incendios y/o lesiones graves con posible consecuencia de muerte.

1. Antes de la puesta en marcha del producto se deberá comprobar siempre que la tensión preseleccionada en el producto coincida con la de la red de alimentación eléctrica. Si es necesario modificar el ajuste de tensión, también se deberán cambiar en caso dado los fusibles correspondientes del producto.
2. Los productos de la clase de protección I con alimentación móvil y enchufe individual solamente podrán enchufarse a tomas de corriente con contacto de seguridad y con conductor de protección conectado.
3. Queda prohibida la interrupción intencionada del conductor de protección, tanto en la toma de corriente como en el mismo producto. La interrupción puede tener como consecuencia el riesgo de que el producto sea fuente de choques eléctricos. Si se utilizan cables alargadores o regletas de enchufe, deberá garantizarse la realización de un examen regular de los mismos en cuanto a su estado técnico de seguridad.
4. Si el producto no está equipado con un interruptor para desconectarlo de la red, o bien si el interruptor existente no resulta apropiado para la desconexión de la red, el enchufe del cable de conexión se deberá considerar como un dispositivo de desconexión. El dispositivo de desconexión se debe poder alcanzar fácilmente y debe estar siempre bien accesible. Si, p. ej., el enchufe de conexión a la red es el dispositivo de desconexión, la longitud del cable de conexión no debe superar 3 m). Los interruptores selectores o electrónicos no son aptos para el corte de la red eléctrica. Si se integran productos sin interruptor en bastidores o instalaciones, se deberá colocar el interruptor en el nivel de la instalación.
5. No utilice nunca el producto si está dañado el cable de conexión a red. Compruebe regularmente el correcto estado de los cables de conexión a red. Asegúrese, mediante las medidas de protección y de instalación adecuadas, de que el cable de conexión a red no pueda ser dañado o de que nadie pueda ser dañado por él, p. ej. al tropezar o por un choque eléctrico.

Instrucciones de seguridad elementales

6. Solamente está permitido el funcionamiento en redes de alimentación TN/TT aseguradas con fusibles de 16 A como máximo (utilización de fusibles de mayor amperaje solo previa consulta con el grupo de empresas Rohde & Schwarz).
7. Nunca conecte el enchufe en tomas de corriente sucias o llenas de polvo. Introduzca el enchufe por completo y fuertemente en la toma de corriente. La no observación de estas medidas puede provocar chispas, fuego y/o lesiones.
8. No sobrecargue las tomas de corriente, los cables alargadores o las regletas de enchufe ya que esto podría causar fuego o choques eléctricos.
9. En las mediciones en circuitos de corriente con una tensión $U_{\text{eff}} > 30 \text{ V}$ se deberán tomar las medidas apropiadas para impedir cualquier peligro (p. ej. medios de medición adecuados, seguros, limitación de tensión, corte protector, aislamiento etc.).
10. Para la conexión con dispositivos informáticos como un PC o un ordenador industrial, debe comprobarse que éstos cumplan los estándares IEC60950-1/EN60950-1 o IEC61010-1/EN 61010-1 válidos en cada caso.
11. A menos que esté permitido expresamente, no retire nunca la tapa ni componentes de la carcasa mientras el producto esté en servicio. Esto pone a descubierto los cables y componentes eléctricos y puede causar lesiones, fuego o daños en el producto.
12. Si un producto se instala en un lugar fijo, se deberá primero conectar el conductor de protección fijo con el conductor de protección del producto antes de hacer cualquier otra conexión. La instalación y la conexión deberán ser efectuadas por un electricista especializado.
13. En el caso de dispositivos fijos que no estén provistos de fusibles, interruptor automático ni otros mecanismos de seguridad similares, el circuito de alimentación debe estar protegido de modo que todas las personas que puedan acceder al producto, así como el producto mismo, estén a salvo de posibles daños.
14. Todo producto debe estar protegido contra sobretensión (debida p. ej. a una caída del rayo) mediante los correspondientes sistemas de protección. Si no, el personal que lo utilice quedará expuesto al peligro de choque eléctrico.
15. No debe introducirse en los orificios de la caja del aparato ningún objeto que no esté destinado a ello. Esto puede producir cortocircuitos en el producto y/o puede causar choques eléctricos, fuego o lesiones.
16. Salvo indicación contraria, los productos no están impermeabilizados (ver también el capítulo "Estados operativos y posiciones de funcionamiento", punto 1). Por eso es necesario tomar las medidas necesarias para evitar la entrada de líquidos. En caso contrario, existe peligro de choque eléctrico para el usuario o de daños en el producto, que también pueden redundar en peligro para las personas.
17. No utilice el producto en condiciones en las que pueda producirse o ya se hayan producido condensaciones sobre el producto o en el interior de éste, como p. ej. al desplazarlo de un lugar frío a otro caliente. La entrada de agua aumenta el riesgo de choque eléctrico.
18. Antes de la limpieza, desconecte por completo el producto de la alimentación de tensión (p. ej. red de alimentación o batería). Realice la limpieza de los aparatos con un paño suave, que no se deshilache. No utilice bajo ningún concepto productos de limpieza químicos como alcohol, acetona o diluyentes para lacas nitrocelulósicas.

Instrucciones de seguridad elementales

Funcionamiento

1. El uso del producto requiere instrucciones especiales y una alta concentración durante el manejo. Debe asegurarse que las personas que manejen el producto estén a la altura de los requerimientos necesarios en cuanto a aptitudes físicas, psíquicas y emocionales, ya que de otra manera no se pueden excluir lesiones o daños de objetos. El empresario u operador es responsable de seleccionar el personal usuario apto para el manejo del producto.
2. Antes de desplazar o transportar el producto, lea y tenga en cuenta el capítulo "Transporte".
3. Como con todo producto de fabricación industrial no puede quedar excluida en general la posibilidad de que se produzcan alergias provocadas por algunos materiales empleados —los llamados alérgenos (p. ej. el níquel)—. Si durante el manejo de productos Rohde & Schwarz se producen reacciones alérgicas, como p. ej. irritaciones cutáneas, estornudos continuos, enrojecimiento de la conjuntiva o dificultades respiratorias, debe avisarse inmediatamente a un médico para investigar las causas y evitar cualquier molestia o daño a la salud.
4. Antes de la manipulación mecánica y/o térmica o el desmontaje del producto, debe tenerse en cuenta imprescindiblemente el capítulo "Eliminación/protección del medio ambiente", punto 1.
5. Ciertos productos, como p. ej. las instalaciones de radiocomunicación RF, pueden a causa de su función natural, emitir una radiación electromagnética aumentada. Deben tomarse todas las medidas necesarias para la protección de las mujeres embarazadas. También las personas con marcapasos pueden correr peligro a causa de la radiación electromagnética. El empresario/operador tiene la obligación de evaluar y señalar las áreas de trabajo en las que exista un riesgo elevado de exposición a radiaciones.
6. Tenga en cuenta que en caso de incendio pueden desprenderse del producto sustancias tóxicas (gases, líquidos etc.) que pueden generar daños a la salud. Por eso, en caso de incendio deben usarse medidas adecuadas, como p. ej. máscaras antigás e indumentaria de protección.
7. Los productos con láser están provistos de indicaciones de advertencia normalizadas en función de la clase de láser del que se trate. Los rayos láser pueden provocar daños de tipo biológico a causa de las propiedades de su radiación y debido a su concentración extrema de potencia electromagnética. En caso de que un producto Rohde & Schwarz contenga un producto láser (p. ej. un lector de CD/DVD), no debe usarse ninguna otra configuración o función aparte de las descritas en la documentación del producto, a fin de evitar lesiones (p. ej. debidas a irradiación láser).
8. Clases de compatibilidad electromagnética (conforme a EN 55011 / CISPR 11; y en analogía con EN 55022 / CISPR 22, EN 55032 / CISPR 32)
 - Aparato de clase A:
Aparato adecuado para su uso en todos los entornos excepto en los residenciales y en aquellos conectados directamente a una red de distribución de baja tensión que suministra corriente a edificios residenciales.
Nota: Los aparatos de clase A están destinados al uso en entornos industriales. Estos aparatos pueden causar perturbaciones radioeléctricas en entornos residenciales debido a posibles perturbaciones guiadas o radiadas. En este caso, se le podrá solicitar al operador que tome las medidas adecuadas para eliminar estas perturbaciones.
 - Aparato de clase B:
Aparato adecuado para su uso en entornos residenciales, así como en aquellos conectados directamente a una red de distribución de baja tensión que suministra corriente a edificios residenciales.

Instrucciones de seguridad elementales

Reparación y mantenimiento

1. El producto solamente debe ser abierto por personal especializado con autorización para ello. Antes de manipular el producto o abrirlo, es obligatorio desconectarlo de la tensión de alimentación, para evitar toda posibilidad de choque eléctrico.
2. El ajuste, el cambio de partes, el mantenimiento y la reparación deberán ser efectuadas solamente por electricistas autorizados por Rohde & Schwarz. Si se reponen partes con importancia para los aspectos de seguridad (p. ej. el enchufe, los transformadores o los fusibles), solamente podrán ser sustituidos por partes originales. Después de cada cambio de partes relevantes para la seguridad deberá realizarse un control de seguridad (control a primera vista, control del conductor de protección, medición de resistencia de aislamiento, medición de la corriente de fuga, control de funcionamiento). Con esto queda garantizada la seguridad del producto.

Baterías y acumuladores o celdas

Si no se siguen (o se siguen de modo insuficiente) las indicaciones en cuanto a las baterías y acumuladores o celdas, pueden producirse explosiones, incendios y/o lesiones graves con posible consecuencia de muerte. El manejo de baterías y acumuladores con electrolitos alcalinos (p. ej. celdas de litio) debe seguir el estándar EN 62133.

1. No deben desmontarse, abrirse ni triturarse las celdas.
2. Las celdas o baterías no deben someterse a calor ni fuego. Debe evitarse el almacenamiento a la luz directa del sol. Las celdas y baterías deben mantenerse limpias y secas. Limpiar las conexiones sucias con un paño seco y limpio.
3. Las celdas o baterías no deben cortocircuitarse. Es peligroso almacenar las celdas o baterías en estuches o cajones en cuyo interior puedan cortocircuitarse por contacto recíproco o por contacto con otros materiales conductores. No deben extraerse las celdas o baterías de sus embalajes originales hasta el momento en que vayan a utilizarse.
4. Las celdas o baterías no deben someterse a impactos mecánicos fuertes indebidos.
5. En caso de falta de estanqueidad de una celda, el líquido vertido no debe entrar en contacto con la piel ni los ojos. Si se produce contacto, lavar con agua abundante la zona afectada y avisar a un médico.
6. En caso de cambio o recarga inadecuados, las celdas o baterías que contienen electrolitos alcalinos (p. ej. las celdas de litio) pueden explotar. Para garantizar la seguridad del producto, las celdas o baterías solo deben ser sustituidas por el tipo Rohde & Schwarz correspondiente (ver lista de recambios).
7. Las baterías y celdas deben reciclarse y no deben tirarse a la basura doméstica. Las baterías o acumuladores que contienen plomo, mercurio o cadmio deben tratarse como residuos especiales. Respete en esta relación las normas nacionales de eliminación y reciclaje.

Transporte

1. El producto puede tener un peso elevado. Por eso es necesario desplazarlo o transportarlo con precaución y, si es necesario, usando un sistema de elevación adecuado (p. ej. una carretilla elevadora), a fin de evitar lesiones en la espalda u otros daños personales.

Instrucciones de seguridad elementales

2. Las asas instaladas en los productos sirven solamente de ayuda para el transporte del producto por personas. Por eso no está permitido utilizar las asas para la sujeción en o sobre medios de transporte como p. ej. grúas, carretillas elevadoras de horquilla, carros etc. Es responsabilidad suya fijar los productos de manera segura a los medios de transporte o elevación. Para evitar daños personales o daños en el producto, siga las instrucciones de seguridad del fabricante del medio de transporte o elevación utilizado.
3. Si se utiliza el producto dentro de un vehículo, recae de manera exclusiva en el conductor la responsabilidad de conducir el vehículo de manera segura y adecuada. El fabricante no asumirá ninguna responsabilidad por accidentes o colisiones. No utilice nunca el producto dentro de un vehículo en movimiento si esto pudiera distraer al conductor. Asegure el producto dentro del vehículo debidamente para evitar, en caso de un accidente, lesiones u otra clase de daños.

Eliminación/protección del medio ambiente

1. Los dispositivos marcados contienen una batería o un acumulador que no se debe desechar con los residuos domésticos sin clasificar, sino que debe ser recogido por separado. La eliminación se debe efectuar exclusivamente a través de un punto de recogida apropiado o del servicio de atención al cliente de Rohde & Schwarz.
2. Los dispositivos eléctricos usados no se deben desechar con los residuos domésticos sin clasificar, sino que deben ser recogidos por separado.
Rohde & Schwarz GmbH & Co.KG ha elaborado un concepto de eliminación de residuos y asume plenamente los deberes de recogida y eliminación para los fabricantes dentro de la UE. Para desechar el producto de manera respetuosa con el medio ambiente, dirijase a su servicio de atención al cliente de Rohde & Schwarz.
3. Si se trabaja de manera mecánica y/o térmica cualquier producto o componente más allá del funcionamiento previsto, pueden liberarse sustancias peligrosas (polvos con contenido de metales pesados como p. ej. plomo, berilio o níquel). Por eso el producto solo debe ser desmontado por personal especializado con formación adecuada. Un desmontaje inadecuado puede ocasionar daños para la salud. Se deben tener en cuenta las directivas nacionales referentes a la eliminación de residuos.
4. En caso de que durante el trato del producto se formen sustancias peligrosas o combustibles que deban tratarse como residuos especiales (p. ej. refrigerantes o aceites de motor con intervalos de cambio definidos), deben tenerse en cuenta las indicaciones de seguridad del fabricante de dichas sustancias y las normas regionales de eliminación de residuos. Tenga en cuenta también en caso necesario las indicaciones de seguridad especiales contenidas en la documentación del producto. La eliminación incorrecta de sustancias peligrosas o combustibles puede causar daños a la salud o daños al medio ambiente.

Se puede encontrar más información sobre la protección del medio ambiente en la página web de Rohde & Schwarz.

Quality management and environmental management

Certified Quality System
ISO 9001

Certified Environmental System
ISO 14001

Sehr geehrter Kunde,

Sie haben sich für den Kauf eines Rohde&Schwarz Produktes entschieden. Sie erhalten damit ein nach modernsten Fertigungsmethoden hergestelltes Produkt. Es wurde nach den Regeln unserer Qualitäts- und Umweltmanagementsysteme entwickelt, gefertigt und geprüft. Rohde&Schwarz ist unter anderem nach den Managementsystemen ISO9001 und ISO 14001 zertifiziert.

Der Umwelt verpflichtet

- Energie-effiziente, RoHS-konforme Produkte
- Kontinuierliche Weiterentwicklung nachhaltiger Umweltkonzepte
- ISO 14001-zertifiziertes Umweltmanagementsystem

Dear customer,

You have decided to buy a Rohde&Schwarz product. This product has been manufactured using the most advanced methods. It was developed, manufactured and tested in compliance with our quality management and environmental management systems. Rohde&Schwarz has been certified, for example, according to the ISO9001 and ISO 14001 management systems.

Environmental commitment

- Energy-efficient products
- Continuous improvement in environmental sustainability
- ISO 14001-certified environmental management system

Cher client,

Vous avez choisi d'acheter un produit Rohde&Schwarz. Vous disposez donc d'un produit fabriqué d'après les méthodes les plus avancées. Le développement, la fabrication et les tests de ce produit ont été effectués selon nos systèmes de management de qualité et de management environnemental. La société Rohde&Schwarz a été homologuée, entre autres, conformément aux systèmes de management ISO 9001 et ISO 14001.

Engagement écologique

- Produits à efficience énergétique
- Amélioration continue de la durabilité environnementale
- Système de management environnemental certifié selon ISO 14001



Customer Support

Technical support – where and when you need it

For quick, expert help with any Rohde & Schwarz equipment, contact one of our Customer Support Centers. A team of highly qualified engineers provides telephone support and will work with you to find a solution to your query on any aspect of the operation, programming or applications of Rohde & Schwarz equipment.

Up-to-date information and upgrades

To keep your instrument up-to-date and to be informed about new application notes related to your instrument, please send an e-mail to the Customer Support Center stating your instrument and your wish. We will take care that you will get the right information.

Europe, Africa, Middle East

Phone +49 89 4129 12345
customersupport@rohde-schwarz.com

North America

Phone 1-888-TEST-RSA (1-888-837-8772)
customer.support@rsa.rohde-schwarz.com

Latin America

Phone +1-410-910-7988
customersupport.la@rohde-schwarz.com

Asia/Pacific

Phone +65 65 13 04 88
customersupport.asia@rohde-schwarz.com

China

Phone +86-800-810-8228 /
+86-400-650-5896
customersupport.china@rohde-schwarz.com



Contents

1	Documentation Overview	9
2	Preparing for Use	13
2.1	Front Panel Tour R&S OSP120	13
2.1.1	Status LEDs and Standby Key	14
2.1.2	Front Panel Connectors	14
2.2	Front Panel Tour R&S OSP130	15
2.2.1	Navigation Keys	16
2.2.2	Status Keys	16
2.2.3	Status Indicators	16
2.2.4	Front Panel USB Connectors	17
2.3	Front Panel Tour R&S OSP150	17
2.4	Rear Panel Tour	17
2.4.1	LAN Connector	18
2.4.2	CAN Bus Connector	19
2.4.3	Mains Switch and Connector	19
2.5	Putting the Instrument into Operation	20
2.5.1	Unpacking the Instrument and Checking the Shipment	20
2.5.2	Instrument Setup	21
2.5.3	Bench Top Operation	21
2.5.4	Mounting in a 19" Rack	21
2.5.5	EMI Protective Measures	21
2.5.6	Connecting the Instrument to the AC Supply	22
2.5.7	Power on and off	22
2.5.8	Replacing Fuses	22
2.5.9	Standby and Ready State	23
2.6	Maintenance	23
2.6.1	Storing and Packing	24
2.7	Connecting External Accessories	24
2.7.1	Connecting a USB Flash Drive	24
2.7.2	Connecting a Keyboard	24
2.7.3	Connecting a Monitor	25
2.7.4	Connecting a LAN Cable	25
2.8	Starting the R&S OSP and Shutting Down	26
2.9	Remote Operation in a LAN	26

2.9.1	Assigning an IP Address.....	26
2.9.2	OSP Panel	29
2.10	Linux Operating System	30
2.10.1	Keyboard Properties	30
2.11	Firmware Update.....	31
2.12	Read the actual the Firmware Version	32
2.12.1	Get Firmware Version using OSP Panel	32
2.12.2	Get Firmware Version via SCPI command.....	33
3	Getting Started.....	34
3.1	Connecting R&S OSP and PC	34
3.2	Installing OSP Panel	35
3.3	OSP Panel Functions	36
3.3.1	Configuring/Connecting OSP Panel	36
3.3.2	Addressing R&S OSP Device.....	38
3.3.3	Changing the IP address with OSP Panel.....	41
3.3.4	General Actions of OSP Panel	42
3.3.5	Addressing R&S OSP Modules	43
3.3.6	Controlling the R&S OSP-B101/-B106/-B107/-B111/-B127/-B132.....	44
3.3.7	Controlling the R&S OSP-B102/-B112/-B128.....	46
3.3.8	Controlling the R&S OSP-B103/-B158	47
3.3.9	Controlling the R&S OSP-B104/-B114	49
3.3.10	Controlling the R&S OSP-B108	53
3.3.11	Controlling the R&S OSP-B131	54
3.3.12	Controlling the R&S OSP-B116/-B136	54
3.3.13	Controlling the R&S OSP-B142	55
3.4	Path Configuration.....	56
3.4.1	Save a Path	57
3.4.2	Switch a Path	59
3.4.3	Delete a Path	59
3.4.4	Export a Path	60
3.4.5	Import a Path	62
3.5	Sample Session	63
3.5.1	Example Path Configuration	63
3.5.2	Manual Setting of the Paths.....	66
3.5.3	Remote Control Setting of the Path Configuration	67
4	Manual Operation	68

4.1	Manual Operation of the Modules	68
4.2	R&S OSP Setups.....	68
5	Instrument Functions	69
5.1	R&S OSP Instrument Frame	69
5.1.1	R&S OSP Block Diagram	70
5.1.2	R&S OSP Module Slots	72
5.1.3	R&S OSP120 Version12 and Module Slots.....	72
5.1.4	R&S OSP120 Version12 and Modules R&S OSP-B011/-B012	73
5.1.5	R&S OSP150 Version15 and Module Slots.....	77
5.1.6	R&S OSP150 Version15 and Modules OSP-B011/-B012	78
5.2	Module Functions	78
5.2.1	RF Switch Module R&S OSP-B101/-B107/-B111/-B127	78
5.2.2	RF Switch Module R&S OSP-B102/-B112/-B128.....	79
5.2.3	I/O Module R&S OSP-B103.....	81
5.2.4	I/O Module R&S OSP-B104.....	83
5.2.5	RF Switch Module R&S OSP-B106/-B132	85
5.2.6	DC MUX Module R&S OSP-B108	87
5.2.7	RF Switch Module R&S OSP-B121 and R&S OSP-B121H	87
5.2.8	RF Switch Module R&S OSP-B122	88
5.2.9	RF Switch Module R&S OSP-B123 and R&S OSP-B124	90
5.2.10	RF Switch Module R&S OSP-B125 and R&S OSP-B126	92
5.2.11	Module R&S OSP-B114 for EMS application	95
5.2.12	RF Switch Module R&S OSP-B131	96
5.2.13	RF Switch Module R&S OSP-B129 and R&S OSP-B119	97
5.2.14	Power Sensor Module R&S OSP-PM-I.....	99
5.2.15	RF Switch Module R&S OSP-B116 and R&S OSP-B136	100
5.2.16	RF Switch Module R&S OSP-B101L and R&S OSP-B102L	101
5.2.17	I/O and supply Module R&S OSP-B158	102
5.2.18	RF Switch Module R&S OSP-B142	103
5.3	Graphical User Interface	104
5.3.1	Starting the R&S OSP120	105
5.3.2	Starting the R&S OSP130	106
5.3.3	General Navigation Operations	106
5.3.4	Using the R&S OSP-B101/-B106/-B107/-B111	109
5.3.5	Using the R&S OSP-B102/-B112	110
5.3.6	Using the R&S OSP-B103	111
5.3.7	Using the R&S OSP-B104	112

5.3.8	Using the R&S OSP-B121	113
5.3.9	Using the R&S OSP-B122	114
5.3.10	Using the R&S OSP-B123 to R&S OSP-B126 and R&S OSP-B129	115
5.3.11	Path Configuration	116
5.4	R&S OSP Switch Cycle Counter.....	120
5.5	R&S OSP Selftest.....	122
5.5.1	Selftest via OSP Panel	122
5.6	R&S OSP Configuration Check	122
5.6.1	System Info via OSP Panel	122
5.7	SCPI Read/Write.....	123
5.7.1	R&S OSP Temperature Read command.....	124
6	Index	127

Figures

Figure 3-1: AU600 panel design	49
Figure 5-1: Block Diagram R&S OSP120	70
Figure 5-2: Block Diagram R&S OSP130	71
Figure 5-3: Block Diagram R&S OSP150	71
Figure 5-4: R&S OSP Module Slots.....	72
Figure 5-5: R&S OSP120 Version12 Module Slots at front side	73
Figure 5-6: Block Diagram R&S OSP120 Var. 12	73
Figure 5-7: Block Diagram R&S OSP120 Var. 12	74
Figure 5-8: R&S OSP-B011 module panel	75
Figure 5-9: R&S OSP-B011 module panel	75
Figure 5-10: R&S OSP150 Version15 Module Slots at front side	77
Figure 5-11: Block Diagram R&S OSP150 Var. 15	77
Figure 5-12: Module R&S OSP-B101	78
Figure 5-13: Block Diagram Module R&S OSP-B101	79
Figure 5-14: Module R&S OSP-B102	80
Figure 5-15: Block Diagram Module R&S OSP-B102	80
Figure 5-16: Module R&S OSP-B128	81
Figure 5-17: Module R&S OSP-B103	82
Figure 5-18: Block Diagram Module R&S OSP-B103	82
Figure 5-19: Module R&S OSP-B104	83
Figure 5-20: Block Diagram Module R&S OSP-B104	85
Figure 5-21: Module R&S OSP-B106	86
Figure 5-22: Block Diagram Module R&S OSP-B106	86
Figure 5-23: Module R&S OSP-B108	87
Figure 5-24: Module R&S OSP-B121	87
Figure 5-25: Block diagram Module R&S OSP-B121	88
Figure 5-26: Module R&S OSP-B122	89
Figure 5-27: Block diagram Module R&S OSP-B122	89
Figure 5-28: Module R&S OSP-B123	90
Figure 5-29: Module R&S OSP-B124	91
Figure 5-30: Block diagram Module R&S OSP-B123	91
Figure 5-31: Block diagram Module R&S OSP-B124	92
Figure 5-32: Module R&S OSP-B125	93
Figure 5-33: Module R&S OSP-B126	93
Figure 5-34: Block diagram Module R&S OSP-B125	94
Figure 5-35: Block diagram Module R&S OSP-B126	94
Figure 5-36: Module R&S OSP-B114	95
Figure 5-37: Block diagram Module R&S OSP-B114	96
Figure 5-38: Module R&S OSP-B131	96
Figure 5-39: Block diagram Module R&S OSP-B131	97
Figure 5-40: Module R&S OSP-B129 and R&S OSP-B119	98
Figure 5-41: Block diagram Module R&S OSP-B129	98
Figure 5-42: Module R&S OSP-PM-I	99
Figure 5-43: Block diagram Module R&S OSP-PM-I	100
Figure 5-44: Block diagram Module R&S OSP-B116	100
Figure 5-45: Module R&S OSP-B116 and R&S OSP-B136	101
Figure 5-46: Module R&S OSP-B101Land R&S OSP-B1012L	101

Figure 5-47: Module R&S OSP-B158 103
Figure 5-48: Block Diagram Module R&S OSP-B158 103
Figure 5-49: Module R&S OSP-B142 (variant .03 with 3 DP3T switches) 104

1 Documentation Overview

The Quick Start Guide describes the following R&S®OSP models and options:

R&S OSP120, stock no. 1505.3009.02/.12

R&S OSP130, stock no. 1505.3009.03

R&S OSP150, stock no. 1505.3009.05/.15

Option Module R&S OSP-B011, stock no. 1505.4763.02

Option Module R&S OSP-B012, stock no. 1505.4770.02

Option Module R&S OSP-B101, stock no. 1505.5101.02

Option Module R&S OSP-B101L, stock no. 1505.5101.52

Option Module R&S OSP-B102, stock no. 1505.5201.02

Option Module R&S OSP-B102L, stock no. 1505.5201.52

Option Module R&S OSP-B103, stock no. 1505.5301.02

Option Module R&S OSP-B104, stock no. 1505.5401.02

Option Module R&S OSP-B106, stock no. 1505.5601.02

Option Module R&S OSP-B107, stock no. 1505.5901.02

Option Module R&S OSP-B108, stock no. 1505.5718.02

Option Module R&S OSP-B111, stock no. 1505.4605.02

Option Module R&S OSP-B112, stock no. 1505.4611.02

Option Module R&S OSP-B114, stock no. 1505.4711.02

Option Module R&S OSP-B116, stock no. 1515.5827.02

Option Module R&S OSP-B119, stock no. 1515.5856.02

Option Module R&S OSP-B121, stock no. 1515.5504.02

Option Module R&S OSP-B121H, stock no. 1515.5504.40

Option Module R&S OSP-B122, stock no. 1515.5510.02

Option Module R&S OSP-B123, stock no. 1515.5527.02

Option Module R&S OSP-B124, stock no. 1515.5533.02

Option Module R&S OSP-B125, stock no. 1515.5540.02

Option Module R&S OSP-B126, stock no. 1515.5556.02

Option Module R&S OSP-B127, stock no. 1505.4728.02

Option Module R&S OSP-B128, stock no. 1505.4734.02

Option Module R&S OSP-B129, stock no. 1515.5556.02

Option Module R&S OSP-B131, stock no. 1505.4740.02

Option Module R&S OSP-B132, stock no. 1505.4757.02

Option Module R&S OSP-B136, stock no. 1522.4500.02

Option Module R&S OSP-B142, stock no. 1528.1048.03/.11/.12/.13

Option Module R&S OSP-B158, stock no. 4094.7300.02

2 Preparing for Use

The following topics will help you to get familiar with the instrument and perform the first steps:

- Front Panel Tour R&S OSP120 or Front Panel Tour R&S OSP130 or Front Panel Tour R&S OSP150
- Rear Panel Tour
- Putting the Instrument into Operation

NOTICE

General Safety Instructions

Please make sure to observe the instructions of the following sections so that you cannot cause damage to the instrument or endanger people. This is of particular importance when you use the instrument for the first time. Also observe the general safety instructions at the beginning of this manual.

2.1 Front Panel Tour R&S OSP120

This chapter gives an overview of the front panel controls and connectors of the R&S OSP120 and gives all information that is necessary to put the instrument into operation and connect external devices. Notes on reinstallation of the instrument software appear at the end of the chapter.

Chapter 3.3, OSP Panel Functions, of this manual provides an introduction to the operation of the instrument by means of the control program OSP Panel. For a description of the operating concept and an overview of the instrument's capabilities refer to the Instrument Functions (chapter 5).

The front panel of the R&S OSP120 consists of STANDBY switch, Status LEDs and connectors. Brief explanations on the function of these items and the rear panel can be found on the next pages.



2.1.1 Status LEDs and Standby Key

The status LEDs and the standby toggle switch are located in the bottom right corner of the front panel. See also chapter 2.5.9.

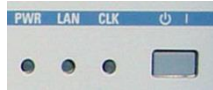

The status LEDs light to indicate the following instrument states:

PWR: shows standby (yellow LED) and ready state (green LED).

LAN: shows if data are received via LAN network (see chapter 6 in the operating manual).

CLK: is flashing if data are transferred via CAN bus.

On an R&S OSP150, the logic is inverted: the CLK indicator goes off shortly during CAN bus activity.

The STANDBY key serves the following purpose:

Toggle between standby and ready state (indicated by the yellow and green PWR LED, respectively).

2.1.2 Front Panel Connectors

2.1.2.1 USB Connectors



Single Universal Serial Bus connectors of type A (master USB), used to connect a keyboard or flash drive. All front panel USB connectors comply with standard USB 2.0; refer to the "Specifications".



USB Connection

The length of passive connecting USB cables should not exceed 1 m. The maximum current per USB port is 500 mA. It is recommended to use double-shielded USB cables.

2.1.2.2 Monitor Connector



An external monitor with a digital interface can be connected to the MONITOR DIGITAL connector on the front panel of the R&S OSP120. An external monitor, together with a keyboard, is a prerequisite for manual intervention in order to define the LAN configuration or in case of service to have access to the Linux Operating system.

Monitor connection:



Before the external monitor is connected, the instrument must be switched off (standby mode) to prevent damage to the monitor and the R&S OSP120. After connection, the external monitor is detected when the instrument is started. The Linux Operating system menu of the R&S OSP is then displayed on the external monitor. Further settings are not required.

It is recommended to use a double-shielded monitor cable equipped with ferrites at each end.

2.2 Front Panel Tour R&S OSP130

This chapter gives an overview of the front panel controls and connectors of the R&S OSP130 and gives all information that is necessary to put the instrument into operation and connect external devices. Notes on reinstallation of the instrument software appear at the end of the chapter.

The chapter Getting Started of this manual provides an introduction to the operation of the instrument by means of the control program OSP Panel. For a description of the operating concept and an overview of the instrument's capabilities refer to the Instrument Functions (chapter 5). The graphical user interface on the instrument is explained in chapter 5.3.

The front panel of the R&S OSP130 has the same STANDBY key and Status LEDs as the R&S OSP120. See the corresponding sections in chapter 2.1.1 for details. There is no connector for an external monitor.



2.2.1 Navigation Keys

The navigation keys allow access to the various functions of the graphical user interface. They can be subdivided into three groups.



In the top row next to the screen there are three keys to quickly access different hierarchy levels in the menus.

pressing the key **MENU** activates the top level menu.

pressing the key **BACK** moves up in hierarchy by one menu level.

pressing the key **HOME** leaves the menu and displays the Main menu screen



In the top row next to the screen there are three keys to quickly access different hierarchy levels in the menus.

With the cursor keys the focus is moved within the screen elements; see a detailed description in chapter 5.3.



In the top row next to the screen there are three keys to quickly access different hierarchy levels in the menus.

pressing the key **FUNCTION** executes a switching action, if applicable.

pressing the key **OK** confirms a selection, for example for going to the next menu level.

pressing the key **STATUS** displays status information for the chosen item (device or module) or changes the selection of a switch for path configuration.

2.2.2 Status Keys

The status keys serve the following purposes:



The **OFF** key is not used at the moment.



The **ON** key is not used at the moment.



Pressing the **RESET** key leaves the menu and displays the Main menu screen.



The **LOCAL** key is not used at the moment.

2.2.3 Status Indicators

The status indicators have the following meaning:

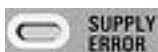

Error in supply voltage, please contact service.



General error condition. Please note any additional information what could have led to this condition and contact R&S if the error is reproducible.



General warning condition. Not used at the moment.



Indicates communication via the CAN interface.



Indicates communication via the CAN interface as well.

2.2.4 Front Panel USB Connectors



Single Universal Serial Bus connectors of type A (master USB), used to connect a keyboard or flash drive. All front panel USB connectors comply with standard USB 2.0; refer to the "Specifications".



USB Connection

The length of passive connecting USB cables should not exceed 1 m. The maximum current per USB port is 500 mA. It is recommended to use double-shielded USB cables.

2.3 Front Panel Tour R&S OSP150

This chapter gives an overview of the front panel controls of the R&S OSP150. The front panel of the R&S OSP150 is similar to the front panel of the R&S OSP120 having the Standby key and the three status LEDs but does not have any connector. See chapter 2.1.1 for the description of the front panel elements.

Please notice that the operation of the CLK LED is different to OSP120 and OSP130.

2.4 Rear Panel Tour

This section gives an overview of the rear panel connectors of the R&S OSP120. The rear panels of the R&S OSP130 and of the R&S OSP150 are almost identical to it.



The rear connectors and interfaces are described in detail in the complete operating manual. The following connectors are available on the instruments:

LAN connector (RJ-45) is used to integrate the instrument to a Local Area Network, primarily for remote control purposes. This connector is not available on the R&S OSP150.

CAN bus connector (D-Sub, 9 pin) is a control port to connect one or several extension units R&S OSP150.

The R&S OSP owns three slots which can be configured with the options available for the R&S OSP. The above configuration shows the following options:

Option R&S OSP-B101: Relay module consisting of six coaxial relays of SPDT type; the RF coaxial connectors are SMA type

Option R&S OSP-B102: Relay module consisting of two coaxial relays of SP6T type; the RF coaxial connectors are SMA type

Option R&S OSP-B103: I/O module with 16 Bit input / output ports; the connectors are D-Sub types, 25 pin, female for output and male for input

In case of the options which can be installed in the R&S OSP, the connectors related to each option are described in detail in chapter R&S OSP Module Interfaces in the operating manual.

2.4.1 LAN Connector



8-pin LAN connector RJ-45 used to connect the R&S OSP120 or OSP130 to a Local Area Network (LAN). Refer to Remote Operation in a LAN.

LAN Connection



Depending on the connection (a non-dedicated network connection or dedicated connection to a single controller) a standard RJ-45 cable or cross-over RJ-45 cable is required. See chapter 2.9.1 for further information.

It is recommended to use double-shielded LAN cables of category 6 (SSTP).

2.4.2 CAN Bus Connector



9-pin connector D-Sub male used to connect the R&S OSP120 or R&S OSP130 to extension units R&S OSP150. Refer to Instrument Functions in chapter 5.

NOTICE

Maximum input levels

The maximum input levels and voltages of the input connectors at the front and rear panel must not be exceeded.

CAUTION

Supply Voltage over CAN bus

In some CAN bus applications the R&S OSP120, OSP130 or OSP150 is required to deliver the supply voltage to an external device. An example for this is the connection of the fiber-optic extender R&S OSP-Z104. Using the cable OSP-Z106 is recommended for this case.

However, when connecting an R&S OSP150 to an OSP120 or OSP130, this supply voltage line must not be present. Using the connecting cables R&S OSP-Z101 or R&S OSP-Z102 is recommended. Not observing these precautions may damage the power supplies in the R&S OSP.

See also chapter 9.1.2.1 in the operating manual for the pinout of the CAN bus connector.

2.4.3 Mains Switch and Connector



The mains connector is located at the bottom left corner of the rear panel.

Next to the connector is a mains fuse, and above the fuse the mains switch. With the positions "0" the instrument is disconnected from mains, and in position "1" it is connected. See chapters 2.5.6 and 2.5.7 for more information.

2.5 Putting the Instrument into Operation

This section describes the basic steps to be taken when setting up the R&S OSP for the first time.

NOTICE

Instrument setup

Before turning on the instrument, please make sure that the following conditions are fulfilled:

Instrument covers are in place and all fasteners are tightened.

Fan openings are unobstructed.

Signal levels at the input connectors are all within the specified ranges.

Signal outputs are correctly connected and not overloaded.

The instrument is dry and shows no condensation.

Non-observance may cause damage to the instrument or other devices in the test setup.

2.5.1 Unpacking the Instrument and Checking the Shipment

Remove the instrument from its packaging and check the equipment for completeness using the delivery note and the accessory lists for the various items.

First, pull off the polyethylene protection pads from the instrument's rear feet and then carefully remove the pads from the instrument handles at the front.

Pull off the corrugated cardboard cover that protects the rear of the instrument.

Carefully unthread the corrugated cardboard cover at the front that protects the instrument handles and remove it.

Check the instrument for any damage. If there is damage, immediately contact the carrier who delivered the instrument. In this case, make sure not to discard the box and packing material.

It is advisable to keep the original packing material in order to prevent control elements and connectors from being damaged in case the instrument is to be transported or shipped at a later date.

2.5.2 Instrument Setup

The R&S OSP is designed for use under laboratory conditions, either on a bench top or in a rack. The general ambient conditions required at the operating site are as follows:

The ambient temperature must be in the ranges specified for operation and for compliance with specifications (see "Specifications").

All fan openings including the rear panel perforations must be unobstructed. The distance to the wall should be at least 10 cm.

2.5.3 Bench Top Operation

If the R&S OSP is operated on a bench top, the surface should be flat.

The instrument is used in horizontal position, standing on its feet.

2.5.4 Mounting in a 19" Rack

The instrument can be mounted in 19" racks using a ZZA-211 adapter (order number 1096.3260.00). Please note the mounting instructions supplied with the rack adapter.

NOTICE

Allow for sufficient air supply in the rack.

Make sure that there is sufficient space between the ventilation holes and the rack casing.

2.5.5 EMI Protective Measures

In order to avoid electromagnetic interference (EMI), the instrument may only be operated when it is closed and with all shielding covers fitted. Only appropriate shielded signal and control cables may be used.

2.5.6 Connecting the Instrument to the AC Supply

The R&S OSP is automatically adapted to the AC supply voltage supplied. The supply voltage must be between 100 V and 240 V with frequencies ranging from 50 Hz to 60 Hz (see also the tolerances quoted in the "Specifications"). The mains connector is located in the lower left corner of the rear panel.

- ▶ Connect the instrument to the AC power source using the AC power cable delivered with the instrument.

The maximum power consumption of the instrument depends on the installed options. The typical power consumption is also listed in the "Specifications".

The R&S OSP is protected by two fuses located in the fuse holder below the AC power switch; see Replacing Fuses.

2.5.7 Power on and off

The mains connector is located at the bottom left corner of the rear panel.



To turn the power on or off, press the AC power switch to position I (On) or 0 (Off).

See also Replacing Fuses.

After power-on, the R&S OSP instrument is in ready state after about 30 seconds.

The STANDBY key at the front panel of the instrument is used to toggle between standby and ready state. The AC power switch can be permanently on.

Switching off is required only if the instrument must be completely removed from the AC power supply but may be used in order to reduce power consumption when not in use.

Extension units



If communication between R&S OSP120 or R&S OSP130 and any extension unit R&S OSP150 connected via CAN bus cannot be established properly, try to turn on the extension unit(s) first before turning on the R&S OSP120 or R&S OSP130.

2.5.8 Replacing Fuses

The instrument is protected by two fuses (IEC 127- T4.0H/250V, stock no. 0020.7600.00) located in the fuse holder below the AC power switch on the rear panel.

WARNING

Shock hazard

For fuse replacement, ensure that the instrument is switched off and disconnected from the power supply by removing the plug from the AC power connector.

To replace the fuses

1. Open the lid of the AC power connector.
2. Lift the fuse holder out of its slot.
3. Exchange the fuses.
4. Put the fuse holder back in its slot and close the lid.

2.5.9 Standby and Ready State

The STANDBY toggle switch is located in the bottom right corner of the front panel.

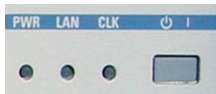

After switching on the AC power, the R&S OSP is in ready mode after about 30 seconds.

Press the STANDBY key on the front panel briefly to switch the R&S OSP from the standby to ready state or vice versa.

In standby state, the left PWR LED is yellow. The standby power only supplies the power switch circuits. In this state it is safe to switch off the AC power and disconnect the instrument from the power supply.

After Power On or when changing from Standby to Ready state, the left PWR LED is immediately switched to green and all modules are power-supplied. Please note that the Linux operating system of R&S OSP takes about 30 seconds to start up. After this time the R&S OSP is ready for operation.

CAUTION

Shock hazard

The instrument is still power-supplied while it is in standby mode.

2.6 Maintenance

The R&S OSP does not require any special maintenance. Make sure that the air vents are not obstructed. The outside of the instrument is suitably cleaned using a soft, non-fluffy dust cloth.

NOTICE

Instrument damage caused by cleaning agents

Cleaning agents contain substances that may damage the instrument, e.g. solvent-containing cleaning agents may damage the front panel labeling or plastic parts. Never use cleaning agents such as solvents (thinners, acetone, etc), acids, bases, or other substances.

For our support center address and a list of useful R&S contact addresses refer to the pages at the beginning of this manual.

2.6.1 Storing and Packing

The R&S OSP can be stored at the temperature range quoted in the data sheet. When it is stored for a longer period of time the instrument should be protected against dust.

The original packing should be used, particularly the protective caps at the front and rear, when the instrument is to be transported or dispatched. If the original packing is no longer available, use a sturdy cardboard box of suitable size and carefully wrap the instrument to protect it against mechanical damage.

2.7 Connecting External Accessories

The LAN interface at the rear panel of the R&S OSP120 or R&S OSP130 is used for remote control of the instrument:

- A LAN connection can be established in order to remotely control the instrument from an external PC (see Connecting a LAN Cable).

In addition the R&S OSP120 provides interfaces for monitor connection and USB connection:

- An external monitor shows the menus of the Linux Operating System, if any access or setup within the Linux Operating System should be necessary.
- A keyboard simplifies the entry of data (see Connecting a Keyboard).
- A flash drive supports the firmware update (see Connecting a USB Flash Drive).

2.7.1 Connecting a USB Flash Drive



A USB flash drive can be connected to one of the USB Connectors on the front panel of the R&S OSP120 or OSP130.

The flash drive is detected automatically when it is connected.

2.7.2 Connecting a Keyboard



A keyboard can be connected to one of the USB Connectors on the front panel of the R&S OSP120.

The keyboard is detected automatically when it is connected. The default input language is English – US. Refer to chapter 2.10.1 for changing the keyboard properties.

Keyboard configuration



The keyboard configuration already is pre-configured.

Operating the R&S OSP120 does not require a keyboard. Usually all essential functions can be controlled via LAN interface.

2.7.3 Connecting a Monitor



A standard monitor can be connected to the DVI-D connector on the front panel of the R&S OSP120.

Monitor configuration



There is no particular configuration of the monitor required.

Operating the R&S OSP120 does not require a monitor. Usually all essential functions can be control via LAN interface.

NOTICE

Monitor connection

The monitor must be connected while the instrument is switched off (in standby mode). Otherwise correct operation can not be guaranteed.

The monitor displays the menus of the Linux Operating System which is integral part of the R&S OSP120. The monitor together with keyboard is required if any setups / changes have to be done in the Linux operating system.

2.7.4 Connecting a LAN Cable



A LAN cable can be connected to the LAN connector on the rear panel of the R&S OSP120 or R&S OSP130. To establish a LAN connection proceed as follows:

Refer to chapter Assigning an IP Address and learn how to avoid connection errors.

Connect an appropriate LAN cable to the LAN port. Use a commercial RJ-45 cable to establish a non-dedicated network connection, or a cross-over RJ-45 cable to establish a dedicated connection between the instrument and a single PC.

Dedicated vs. non-dedicated network connections

There are two methods to establish a LAN connection of the R&S OSP:

- A non-dedicated network (Ethernet) connection from the instrument to an existing network made with an ordinary RJ-45 network cable. The instrument is assigned an IP address and can coexist with a computer and with other hosts on the same network.
- A dedicated network connection between the instrument and a single computer made with a cross-over RJ-45 network cable. The computer must be equipped with a network adapter and is directly connected to the instrument. The use of hubs, switches, or gateways is not needed, however, data transfer is still made using the TCP/IP protocol.

2.8 Starting the R&S OSP and Shutting Down

To start the R&S OSP, proceed as follows:

- Make sure that the instrument is connected to the AC power supply and switch the power switch (see chapter 2.5.7) on the rear panel to position I (On). All modules of the R&S OSP are powered (the left PWR LED is green) and after about 30 seconds the instrument is in ready state.
- If necessary, press the STANDBY toggle switch (see chapter 2.5.9) on the front panel to switch the instrument to ready state (the left PWR LED is green).
- In ready state, the instrument already has booted the Linux Operating System (see chapter 2.10) and started the R&S OSP application. Independent of the last setup, the R&S OSP always starts with the default conditions, i.e. all relays in reset condition.

To shut down the R&S OSP, proceed as follows:

- Press the STANDBY key, which will shut down the Linux operating system and set the instrument to standby state.
- If desired, set the AC power switch to position 0 (Off).

NOTICE

Standby state

It is recommended to switch the R&S OSP to standby state before disconnecting it from the AC supply.

2.9 Remote Operation in a LAN

A LAN connection is used to integrate the R&S OSP (not the R&S OSP150) into a home/company network. The LAN connection is required for:

- Remote control operation of the R&S OSP120 or R&S OSP130.
- Manual control of the R&S OSP from a remote computer using the "OSP Panel" application.

To establish the connection proceed as follows:

- Assign an IP address to the R&S OSP following the directions below and connect the instrument to the network as described in chapter Connecting a LAN Cable.

2.9.1 Assigning an IP Address

There are two different modes for the OSP LAN configuration. The R&S OSP as it is delivered works in the LAN configuration as described in chapter 2.9.1.1.

With OSP firmware version 2.51 onwards, the OSP LAN configuration can be setup as described in chapter 2.9.1.2.

The actual LAN configuration can be read out from the R&S OSP by the following SCPI command:

```
SYSTEM:NETWORK:MODE?
```

2.9.1.1 Default mode of LAN Configuration

The actual LAN configuration is set to mode -> DHCP_AUTO

Depending on the network capacities, the IP address information for the R&S OSP120 or R&S OSP130 can be obtained in different ways.

- If the network supports dynamic TCP/IP configuration using the Dynamic Host Configuration Protocol (DHCP), all address information can be assigned automatically.
- If the network does not support DHCP, or if the instrument is set to use alternate TCP/IP configuration, a static IP address is used.

By default, the R&S OSP is configured either to use:

- A dynamic TCP/IP configuration and obtain all address information automatically. This means that it is safe to establish a physical connection to the LAN without any previous R&S OSP configuration.
(Priority 1)
- A user defined static IP address. This address can be defined (but must not) in addition to the default address. See chapter 3.3.3 for information how to configure the user defined IP address via the OSP Panel application.
(Priority 2)
- A static default IP address. Per default, the R&S OSP is set to the IP address 192.168.48.147. See also chapter 3.1.
(Priority 3)

Please note the priorities shown above which is related to IP address handling done by the R&S OSP.

NOTICE

Valid IP addresses

If your network does not support DHCP, or if you choose to disable dynamic TCP/IP configuration, you must assign valid address information before connecting the R&S OSP to the LAN. Contact your network administrator to obtain a valid IP address, because connection errors can affect the entire network.

Reading the IP address

When using the dynamic TCP/IP configuration, the actual IP address information will be displayed when booting the R&S OSP. Proceed as follows:

Connect the R&S OSP via a commercial RJ-45 cable to your network supporting DHCP

Switch on the R&S OSP120 with Monitor and Keyboard connected (not applicable to the R&S OSP130)

At the end of the booting process, the IP address will be displayed as shown below for the R&S OSP120 and the R&S OSP130. The values of the IP address shown are only examples.

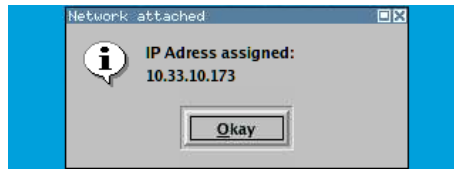

Press Okay button or the ENTER key on the keyboard (OK key for the R&S OSP130) for confirmation and to continue the operation.

Manual TCP/IP configuration

If your network does not support DHCP, proceed as follows:

1. Connect the R&S OSP120 or OSP130 via a cross-over RJ-45 cable to your computer (or network not supporting DHCP).
2. Set the network configuration of your computer to work with a static IP address. The following setup is recommended:

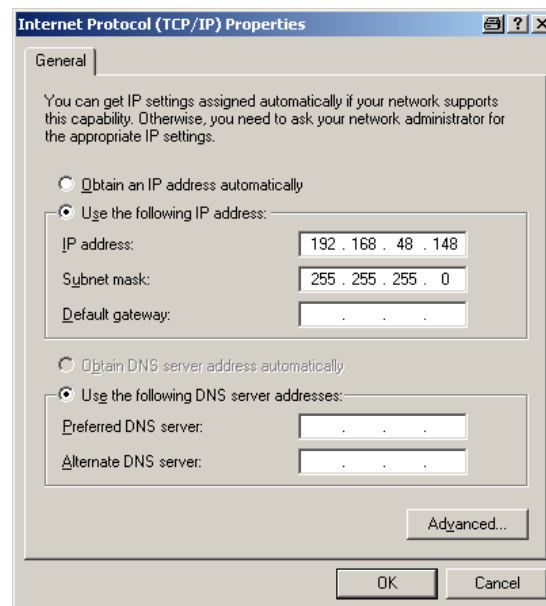

3. Switch on the R&S OSP and wait until boot-up is finished.

The R&S OSP now can be accessed under its default IP address from your computer.

2.9.1.2 Specific mode of LAN Configuration

The R&S OSP120 can be configured to enable gateway routing.

The actual LAN configuration is set to mode -> DHCP-STATIC

The LAN configuration can be setup using the OSP Panel application. See chapter 3.3.3.

The change over to DHCP-STATIC mode is achieved by the following SCPI command:

```
SYSTEM:NETWORK:STATIC "<IpAddr>","<Netmask>","<Gateway>".
```

2.9.2 OSP Panel

The R&S OSP120 has no elements for front panel operating. A "manual" operation is achieved via the R&S application OSP Panel.

"OSP Panel" is a Windows application which can be used to access and control the R&S OSP120 or the R&S OSP130 from a remote computer through a LAN connection. The OSP Panel allows full access to all R&S OSP functions.

To start the OSP Panel connection

1. Connect the R&S OSP to a LAN and determine its IP address; see Remote Operation in a LAN. It is necessary to have a VISA library installed on your computer.
2. Install the OSP Panel application on your computer (connected to the LAN). The VISA libraries which are necessary for running the OSP Panel are available on a separate disc (NI-VISA I/O Library).
3. Start the OSP Panel, specify the correct IP address in the OSP Panel, and the R&S OSP can be manually controlled.

For detailed information about OSP Panel refer to the chapter 3.3 OSP Panel Functions.

2.10 Linux Operating System

The R&S OSP is equipped with a Linux operating system which has been configured according to the instrument's features and needs. Changes in the system configuration can be necessary in order to

- Establish a LAN connection.
- Customize the properties of the keyboard connected to the R&S OSP120.
- Call up additional software tools.

NOTICE

Configuration of the operating system, updates

The operating system is adapted to the R&S OSP. To avoid impairment of instrument functions, only change the settings described in this manual. Existing software must be modified only with update software released by Rohde & Schwarz. Likewise, only programs authorized by Rohde & Schwarz for use on the instrument must be executed.

2.10.1 Keyboard Properties

The keyboard properties can be changed via the console of the Linux Operating System. To customize the keyboard properties, perform the following steps:

1. Switch off the R&S OSP.
2. R&S OSP120: Connect the external monitor and keyboard to the R&S OSP120 and switch on the instrument. The messages of the Linux boot process are displayed on the monitor. Wait until the boot process is finished (takes about 30 seconds) and press the <ENTER> key.
3. R&S OSP130: Connect the external keyboard to the R&S OSP120 and switch on the instrument. Wait until booting is complete. Change from regular display to Linux system login by pressing the keys CTRL + ALT + F3.
4. When asked for the login, use the login name **root** and the password **root**.

To change the keyboard properties to German, type <de> and conform with the <ENTER> key. The keyboard properties will be kept until the instrument is switched off. After booting of the instrument, the default keyboard configuration (English US) is set up again.

2.11 Firmware Update

This chapter contains information on firmware update and Linux operating system update to the R&S OSP120 or R&S OSP130.

NOTICE

Possible impairment of the functioning of the instrument

The instrument is equipped with the Linux operating system. It is thus possible to install COTS software in the instrument. The use and installation of commercial off-the-shelf (COTS) software may impair the instrument function. For this reason, we recommend that you only execute programs tested by Rohde & Schwarz with regard to their compatibility with the instrument software. In certain cases, the use of these programs can impair the performance of the instrument.

The drivers and programs used in the instrument under Linux have been adapted to the test instrument. Existing instrument software must only be modified with update software released by Rohde & Schwarz.

The firmware update packages for the R&S OSP120 and R&S OSP130 are integrated in a single setup file "OSP<xxx>.rsu" (<xxx> denotes the version of the firmware update). Firmware updates as well as the Release Notes describing the improvements and modifications are provided on the Internet at the download site of the R&S OSP homepage.

The installation of a new firmware version is performed via the USB interface. A de-installation of the old firmware is not necessary. The firmware update is performed while the instrument is running. The new firmware will be loaded right after the update process.

To perform a firmware update, perform the following steps.

1. The update file has to be downloaded from the Internet to a PC. From there the file should be transferred to a USB flash drive which will later be plugged into the USB interface of the R&S OSP.
2. Connect the external monitor and keyboard to the R&S OSP120 and switch on the instrument. Wait until booting is complete.
3. Connect the USB flash drive to one of the two USB interfaces on the R&S OSP front panel. If the instrument recognizes a flash drive at its USB interface, and finds valid update versions, the Software Update Process is started. Press the Yes button (OK key on R&S OSP130) to continue.

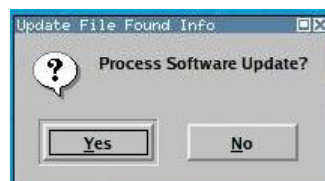

All update versions (files with extension .rsu) stored on the flash drive now are offered

for selection. Thus, an upgrade or downgrade of the firmware is possible at any time. Select the required firmware update version and press the OK button.

NOTICE

It is recommended not to switch off the instrument or to remove the USB flash drive while the firmware update is running.

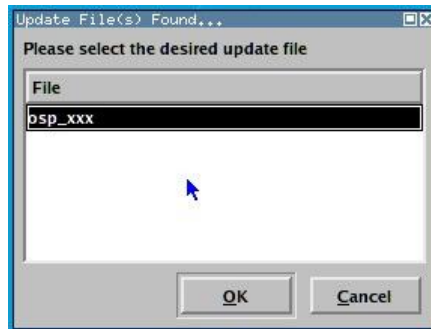

If the software update is complete, the USB flash drive has to be removed. A message box is coming up to confirm the removal of the flash drive. After confirmation the instrument starts rebooting.

The R&S OSP is now ready to operate with the new firmware version.

Before using the R&S OSP, repeat the registration process. See chapter 3.3.2 for details.

CAUTION

Firmware Update:

The firmware update is not allowed to be performed running the GUI via Web-Browser and VNC. Doing this will abort the firmware installation procedure!

2.12 Read the actual the Firmware Version

The currently installed firmware version of the different R&S OSP units can be read in several ways as described in the following chapters.

2.12.1 Get Firmware Version using OSP Panel

The firmware versions of all OSP models can be read using the application OSP Panel. Start the OSP Panel and select the function >File >System Info.

This function displays the OSP System information together with the actual Firmware version. The Firmware version is shown in the OSP Identification string as highlighted in the following example (Version 1.5).

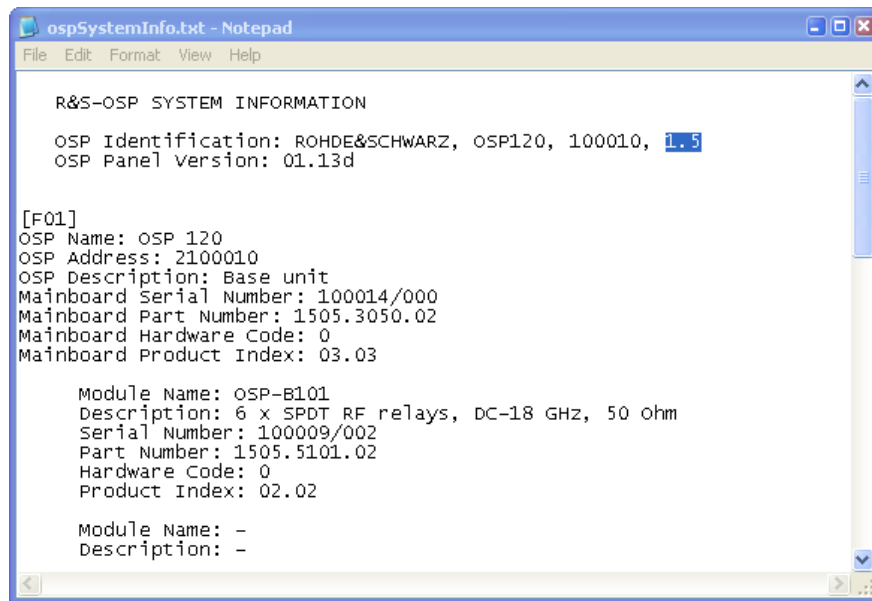

```

ospSystemInfo.txt - Notepad
File Edit Format View Help

R&S-OSP SYSTEM INFORMATION

OSP Identification: ROHDE&SCHWARZ, OSP120, 100010, 1.5
OSP Panel version: 01.13d

[F01]
OSP Name: OSP 120
OSP Address: 2100010
OSP Description: Base unit
Mainboard Serial Number: 100014/000
Mainboard Part Number: 1505.3050.02
Mainboard Hardware Code: 0
Mainboard Product Index: 03.03

Module Name: OSP-B101
Description: 6 x SPDT RF relays, DC-18 GHz, 50 Ohm
Serial Number: 100009/002
Part Number: 1505.5101.02
Hardware Code: 0
Product Index: 02.02

Module Name: -
Description: -

```

2.12.2 Get Firmware Version via SCPI command

In remote mode the current R&S OSP Firmware Version can be read via the “*IDN?” command. When sending the Identification command, the R&S OSP prompts back the following answer (example for R&S OSP120) after pressing the Read button (see below example).

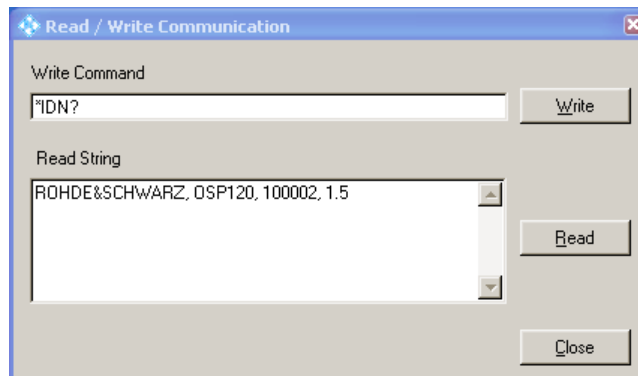

The last part of the string shows the actual firmware version (1.5 for the above example).

With Firmware version 2.51 onwards, the actual version of the R&S OSP is read-out in the configuration string, too.

See below example for R&S OSP120 with Ser. No. 100008 and Var 02:

Rohde&Schwarz, OSP120, 100008, Var02, 2.51

3 Getting Started

This chapter helps you to get familiar with the R&S OSP and explains how to solve basic tasks that you will frequently encounter when working with the instrument. Since the R&S OSP120 only has remote control capability, the manual operation of the instrument is achieved via the application OSP Panel which runs on an external computer connected to the same LAN network as the R&S OSP120. The OSP Panel, however, can also be used with the R&S OSP130.

The following chapter gives a short overview on the operation of the OSP Panel as

- Installing OSP Panel
- OSP Panel Functions
- Sample Session

CAUTION

Risk of shock hazard and instrument damage

Before starting any measurement on your R&S OSP, please note the instructions given in chapter Preparing for Use.

In the chapter Manual Operation you will find information on customizing the instrument according to your personal preferences. Chapter 8 in the operating manual also provides information on typical applications of the R&S OSP platform.

In the following we assume that you are familiar with standard Windows dialogs and mouse operation.

3.1 Connecting R&S OSP and PC

Please read chapter 2.9.1 for understanding the possibilities of IP address assignments. The following setup describes the connection of the R&S OSP120 or R&S OSP130 within a dedicated network; i.e. the connection to a single computer, in case you are not using the dynamic TCP/IP configuration (DHCP).

When using the dynamic TCP/IP configuration (DHCP), these steps are not required.



To set up a LAN connection, proceed as follows:

- Connect the R&S OSP to the computer using a cross-over RJ-45 cable: Ensure that the network configuration of the computer is set to the required protocol. Select >Settings >Control Panel >Network Connections. Select the

properties of the active interface, then the properties of the TCP/IP protocol, and set the following IP address:

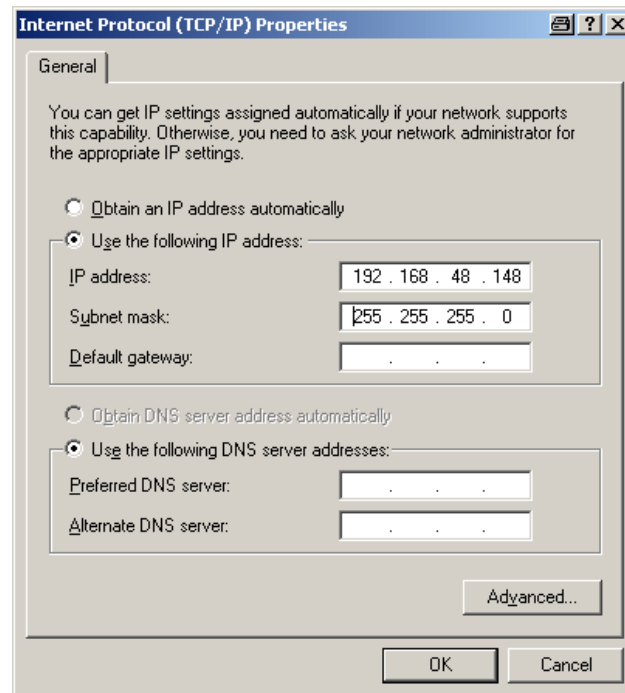

- The R&S OSP is configured by default to IP address **192.168.48.147**. This address is to be entered in the OSP Panel application when using the examples described in the following chapters.

When a static IP address other than the default address is required, it can be changed using the OSP Panel. See chapter 3.3.3 for detailed information.

3.2 Installing OSP Panel

The OSP Panel installation setup is available on CD which is part of the R&S OSP delivery.

The installation setup includes the VISA libraries which are necessary for running the OSP Panel.

To install the application, proceed as follows:

- Insert the documentation CD on the disk drive of your computer.
- Select the directory "OSP Panel" on the CD, select the file setup.exe and press the <ENTER> button to start the installation.
- If the installation is complete, confirm and exit the installation program.

3.3 OSP Panel Functions

The following sections can help you to make efficient use of the OSP Panel, which is the application for manual control of the R&S OSP120 and may also be used in connection with the R&S OSP130. The OSP Panel offers the following features:

- Configuration of the IP address
- Dialogs to control the different options configured in the R&S OSP
- Definition of path configurations
- Direct access to SCPI commands

The following examples are based on the assumption that the IP address has been obtained dynamically to be 10.33.10.173.

3.3.1 Configuring/Connecting OSP Panel

When starting the OSP Panel, no instrument is connected via LAN network. The OSP Panel is in simulation mode and the following dialog appears:

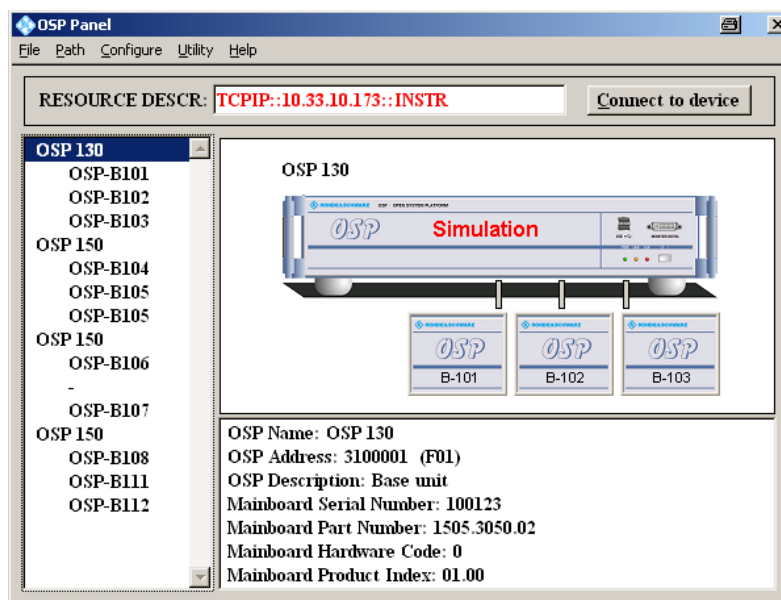

The R&S OSP remains in simulation mode as long as no connection to an instrument via LAN is performed.

To connect an R&S OSP via LAN, perform the following steps:

1. Get the actual IP address as described in chapter 3.1 and enter the address in the input field RESOURCE DESCR.
2. Press the "Connect to device" button at the upper right corner of the OSP Panel dialog to connect the instrument.

Connect to device

If your computer is equipped with a firewall function, it may be necessary to allow the firewall to unlock the OSP Panel. Here is an example of such a firewall message:

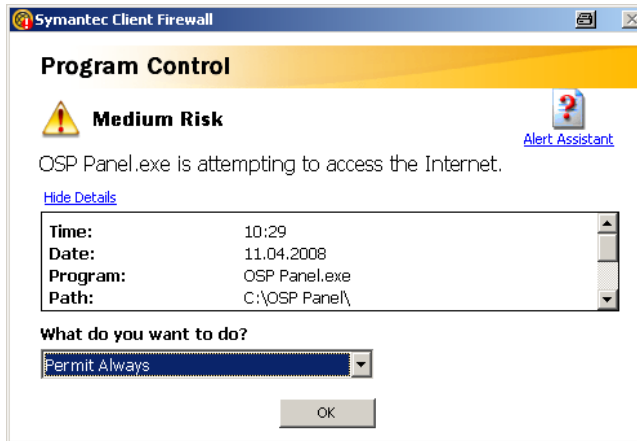

It is recommended to allow free access to Internet for the OSP Panel.

If the LAN connection is established, the R&S OSP device found on the LAN network is displayed in the left field together with the installed options.



Note that it is necessary to register the R&S OSP once, if the instrument is switched on for the first time or if the configuration has changed or if a firmware update has been made. See chapter 3.3.3 for further information. See also chapter 8.2 in the operating manual for actions related to extensions with an R&S OSP150.

In the below example, an R&S OSP130 Device is found on the network which is equipped with three modules R&S OSP-B101, R&S OSP-B104 and R&S OSP-B102. Furthermore, to this device an R&S OSP150 is connected which is equipped with three modules R&S OSP-B101, R&S OSP-B102 and R&S OSP-B103.

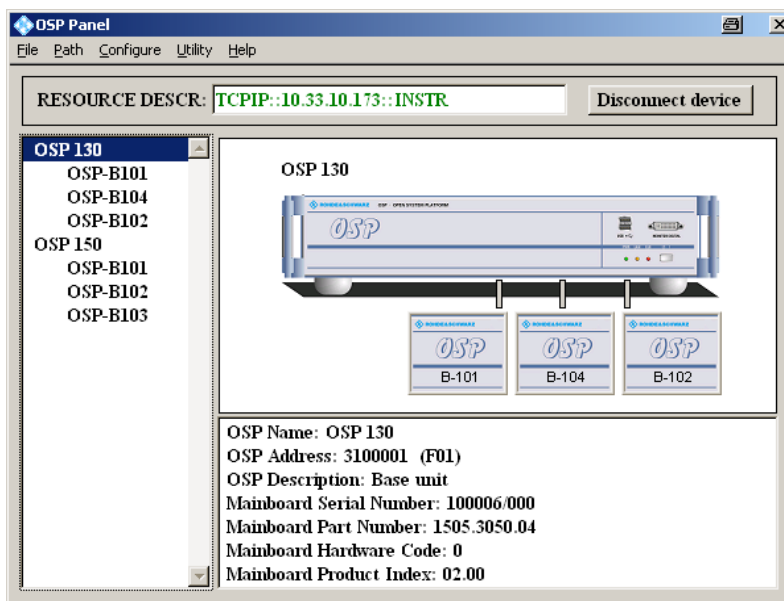

3.3.2 Addressing R&S OSP Device

Select the R&S OSP device in the left field of the OSP Panel dialog.

In the lower right field of the OSP Panel dialog additional information on the R&S OSP is displayed as follows:

OSP Name: OSP 130
 OSP Address: 3100001 (F01)
 OSP Description: Base unit
 Mainboard Serial Number: 100006/000
 Mainboard Part Number: 1505.3050.04
 Mainboard Hardware Code: 0
 Mainboard Product Index: 02.00

OSP Name	Shows the model of the R&S OSP; i.e. R&S OSP130
OSP address	<p>The device address is read back from the R&S OSP flash memory. The first R&S OSP device (the device which can be addressed via LAN interface) in a system is preferably defined as Device F01.</p> <p>The R&S OSP address is composed out of the R&S OSP version (last digit of the R&S OSP Ident Number) and the R&S OSP serial number (6 digit number):</p> <p>Version: xxxx.xxxxK03</p> <p>Serial Number: 100001</p> <p>The above example results in R&S OSP address → 3100001</p>
OSP Description	Base unit (R&S OSP120, R&S OSP130) or Extension unit (R&S OSP150)
Mainboard Serial Number:	The serial number read back from the R&S OSP Mainboard is displayed.
Mainboard Part Number	The part number read back from the R&S OSP Mainboard is displayed.
Mainboard Hardware Code	The hardware code read back from the R&S OSP Mainboard is displayed.
Mainboard Product Index	The product index read back from the R&S OSP Mainboard is displayed.

R&S OSP device

Note that no functions can be set selecting the R&S OSP Device. For the R&S OSP Device only the additional information as listed above can be read.



R&S OSP address

If an R&S OSP is set up for the first time, it is necessary to register the R&S OSP address once. Otherwise it may happen that the R&S OSP is correctly detected but no modules are indicated.

To register the R&S OSP proceed as follows:

3. Connect the instrument via LAN with the computer, where the OSP Panel is running (see chapter 3.3.1)
4. Start the OSP Panel, set the correct IP address, and select Connect to device.
5. Select **>Configure >System** in the OSP Panel.

The following dialog allows to register the R&S OSP:

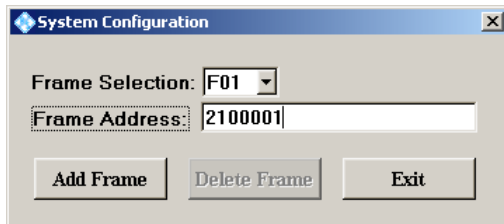

The R&S OSP device which is connected to the LAN network is recommended to be defined as device F01 indicating the first R&S OSP device connected with this IP address. Up to 9 instruments can be connected to the same IP address. They are distinguished by different frame numbers from F01 to F09.



1. Use the drop-down list to set the device number to F01.



2. Type in the device address

The R&S OSP address is composed out of the OSP version (last digit of the OSP part number) and the OSP serial number (6 digit number): The information of the OSP version and the serial number can be found on the serial number label above the mains switch on the OSP's rear side:



- Use the drop-down list to set the device number to F01.



Version (R&S OSP120): xxxx.xxxxK02

Serial Number: 100001

The above example results in R&S OSP address → 2100001



3. Pressing the Add Frame button sends a corresponding command to the R&S OSP and the information is stored on the OSP flash memory.

The next time the OSP Panel is started and connected to the R&S OSP, the correct device information is read back from the R&S OSP flash memory and all available R&S OSP modules are listed correctly.

Configuration changes



Whenever the configuration has changed by adding or removing R&S OSP150 extension units, you must repeat registration. For this purpose, remove all frames except the first one (F01), and insert them if required as new ones.

See also chapter 8.2 in the operating manual for extensions with an R&S OSP150.

3.3.3 Changing the IP address with OSP Panel

The OSP Panel supports the setting of the user defineable static IP address. Please note that this function is supported in OSP Panel version 2.00 onwards. Depending on the two possibilities of the LAN configuration mode with the R&S OSP, the following menus are offered .

3.3.3.1 LAN configuration mode DHCP_AUTO

See chapter 2.9.1.1 for more information on the LAN configuration mode.

Select the menu function >Configure >TCPIP and the following dialog is opened:

The upper half of the dialog shows the last used DHCP address and the actual static IP address.

A new user defined static IP address can be entered together with a subnet mask.

Changing of IP address



Whenever the IP address is changed via the OSP Panel and the previous one was used for OSP Panel communication, you must disconnect the OSP Panel, change the address in the OSP Panel menu and connect to the device again.

The OSP Panel outputs a corresponding message to the operator when changing the static IP address.

3.3.3.2 LAN configuration mode DHCP_STATIC

See chapter 2.9.1.2 for more information on the LAN configuration mode.

Select the menu function >Configure >TCPIP and the following dialog is opened:

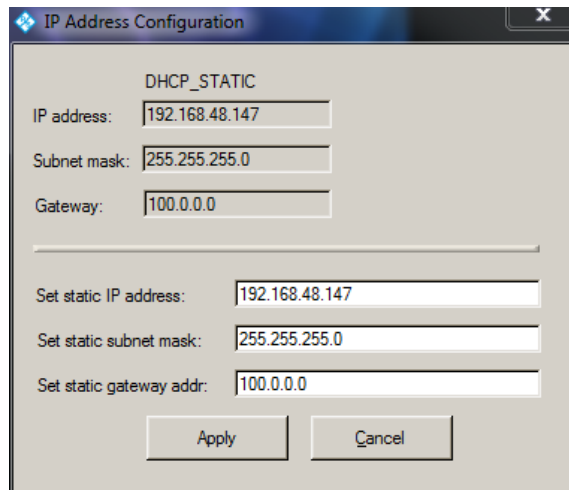

The screenshot shows a dialog box titled "IP Address Configuration". At the top, it indicates the mode is "DHCP_STATIC". There are three input fields: "IP address" with the value "192.168.48.147", "Subnet mask" with "255.255.255.0", and "Gateway" with "100.0.0.0". Below these fields is a horizontal line. Underneath the line are three more input fields: "Set static IP address" with "192.168.48.147", "Set static subnet mask" with "255.255.255.0", and "Set static gateway addr" with "100.0.0.0". At the bottom of the dialog are two buttons: "Apply" and "Cancel".

The menu allows to specify the static address together with the gateway address.

3.3.4 General Actions of OSP Panel

There are several general actions which can be done from the OSP Panel.

With the menu function >Configure >Reset all switches in the connected R&S OSP are set to their default positions.

The functions >Configure >Select all Switches and >Configure >Deselect all Switches define the starting point when collecting the settings for a path configuration. See chapter 3.4 for more details.

The menu function >Utility > Re-Initialize Frames and Modules will re-establish the communication link between the R&S OSP and its modules as well as to all extension units R&S OSP150. Switch settings are not changed.

Other actions are described in the various parts of chapters 3.3 to 3.5.

3.3.5 Addressing R&S OSP Modules

If the R&S OSP Device is correctly registered (see previous chapter), all R&S OSP modules available are displayed in the OSP Panel dialog. To control the R&S OSP modules, the following ways are possible:

1. Select the required module displayed in the left field of the OSP Panel dialog.
or
2. Select the diagram of the required module in the upper right field of the OSP Panel dialog.

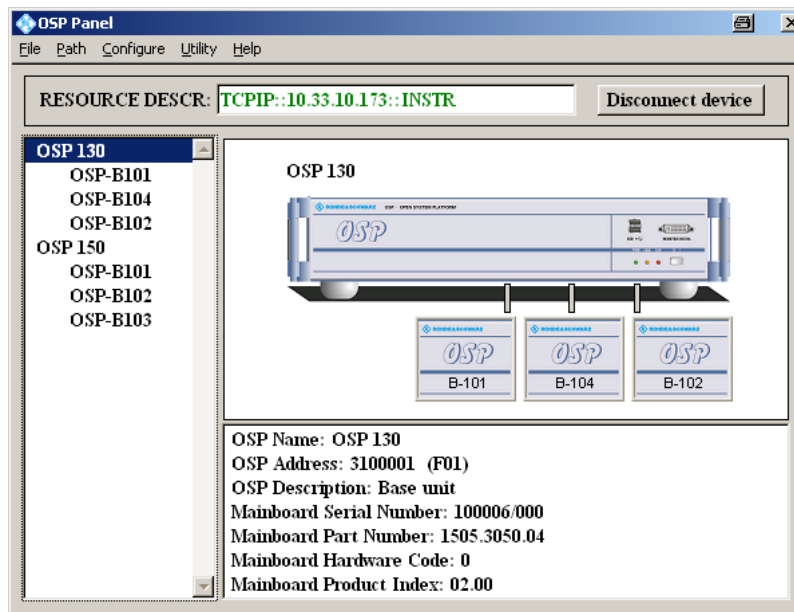

By double-clicking the required R&S OSP module, a window is opened which shows all the setup functions available for the selected module. The title line of that window also indicates the slot where this module is placed, or both slots if the module has double width (see also chapter 5.1.2). See the following chapters for the dialogs of the different R&S OSP modules.



R&S OSP module configuration

If modules are configured in the R&S OSP but no modules are detected by the OSP Panel (indicated in blue), please check that the R&S OSP Device is registered correctly. Refer to chapter 3.3.2 to register the R&S OSP Device.

3.3.6 Controlling the R&S OSP-B101/-B106/-B107/-B111/-B127/-B132

The module R&S OSP-B101 contains six RF switches of SPDT type.

After selection of the R&S OSP-B101 module the following dialog is opened.

The module R&S OSP-B101 contains six RF switches of SPDT type, which is shown in the OSP-B101 dialog.

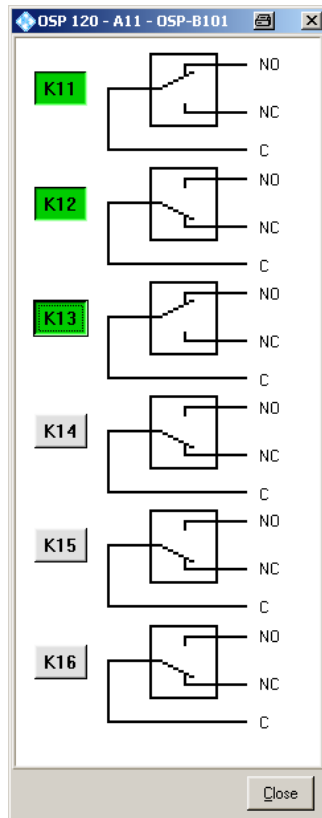

Clicking to the symbol of the relay, the position of each relay can be toggled individually.



SPDT switch

Note that the terminal NC assigns the Normally Closed position. When the relay is not activated, terminal NC is connected to terminal C.

The terminal NO is the Normally Open position. If the relay is activated, the terminal NO is connected to terminal C.

The buttons K11 up to K16 are not required for manual operation of the switches, but for defining a path configuration.

K12

Any button K11 up to K16 in grey color indicates that this relay is not selected. A non selected relay is not considered when defining a path configuration.

K11

To take over particular relays into the path configuration, the relay buttons must be selected by clicking on each of the relay buttons required. The selected relay is displayed with a button in green color. All relays whose relay buttons are selected are

taken over into a path configuration.

Pressing the Shift key while clicking on a relay button will toggle between selecting all relays of this module and deselecting all of them.

Relay configuration



R&S OSP-B101 dialog

When the dialog for operation of the R&S OSP-B101 module is opened, the actual relay setting of this module is read back from the hardware and displayed.

The dialog as described above applies to further options of the R&S OSP as far as the option has got a similar relay configuration. It will apply to the following modules:

Option	Relay configuration
R&S OSP-B106	3 x SPDT relay with N connectors, 12 GHz, 3 x SPDT relays with BNC connectors, 900 MHz / 2 A
R&S OSP-B107	6 x SPDT relay, solid state, 6 GHz
R&S OSP-B111	6 x SPDT relay, 40 GHz
R&S OSP-B127	6 x SPDT relay, solid state, terminated, 10 GHz
R&S OSP-B132	6 x SPDT relay with N connectors, 12 GHz



Relay numbering

Please note that for the module R&S OSP-B106 the relays are numbered from K1 to K6 but from K11 to K16 for all other modules.

3.3.7 Controlling the R&S OSP-B102/-B112/-B128

After selection of the R&S OSP-B102 module the following dialog is opened.

The module R&S OSP-B102 contains two RF switches of SP6T type, which is shown in the R&S OSP-B102 dialog.

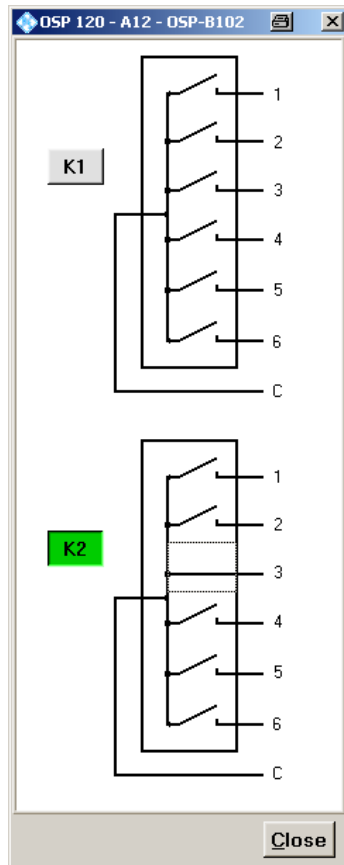

Clicking on any of the six positions of the two relays, this relay will switch to the associated terminal. Clicking on a closed position will open it and reset this relay.



SP6T switch

Note that for this type of relay only one terminal (1 of 6) can be activated at the same time. If no terminal is activated, the relay is in open position.

The buttons K1 and K2 are not required for manual operation of the switches, but for defining a path configuration (see chapter 3.4).

K1

A button K1 and/or K2 in grey color indicates that this relay is not selected. A non selected relay is not considered when defining a path configuration.

K2

To take over particular relays into the path configuration, the relay buttons must be selected by clicking on each of the relay buttons required. The selected relay is displayed with a button in green color. All relays whose relay buttons are selected are taken over into a path configuration.

- ▶ Pressing the Shift key while clicking on a relay button will toggle between selecting all relays of this module and deselecting all of them.



R&S OSP-B102 dialog

When the dialog for operation of the R&S OSP-B102 module is opened, the actual relay setting of this module is read back from the hardware and displayed.

The dialog as described above applies to further options of the R&S OSP as far as the option has got the same relay configuration. It will apply to the following modules:

Option	Relay configuration
R&S OSP-B112	2 x SP6T relay, 40 GHz
R&S OSP-B128	Up 3 x SP6T relay, solid state, terminated, 10 GHz

3.3.8 Controlling the R&S OSP-B103/-B158

After selection of the R&S OSP-B103 or the R&S OSP-B158 module the following dialog is opened.

The module R&S OSP-B103 contains two parallel ports, one with 16 output lines and one with 16 input lines. The R&S OSP-B103 dialog shows both ports:

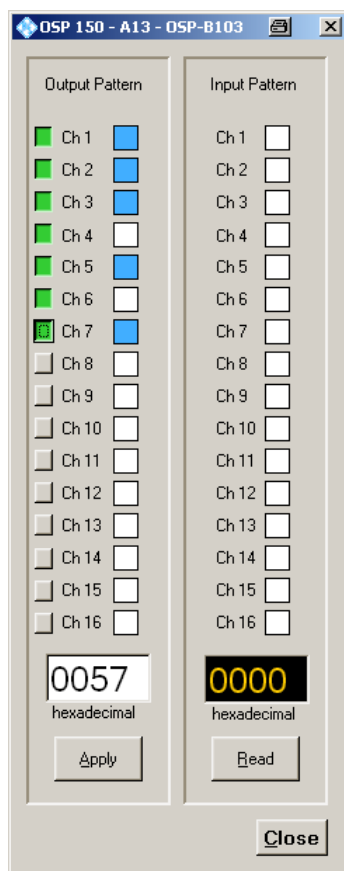

3.3.8.1 Setting the Output Pattern

Clicking on one of the channel buttons in the output pattern field, the status of the output channel can be changed.

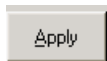
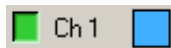
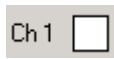
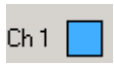

1. An output channel marked in blue color indicates that the output channel is switched to low level (GND). Switching is performed on an active low signal, therefore the blue color indicates the active state.
2. An output channel marked in white color indicates, that the output channel is in high impedance state. This is also the default after reset.
3. To take over particular channels of the output port into the path configuration, the button left to the channels of the output pattern must be selected by clicking on each button of the required outputs. The selected output channel is displayed in green color. All output ports with selected (green) buttons are taken over into a path configuration.
4. Pressing the Shift key while clicking on a relay button will toggle between selecting all relays of this module and deselecting all of them.
5. Pressing this button sets the R&S OSP-B103 outputs to the defined output pattern.
6. The actual setting of the R&S OSP-B103 outputs now is displayed in the output pattern field (Ch1 to Ch16).
7. The hexadecimal representation of the output pattern is displayed in the R&S OSP-B103 dialog, too. Ch1 corresponds to the lowest bit, having the value 1, whereas Ch16 is the highest bit, having the value 8000.

R&S OSP-B103 dialog



When the dialog for operation of the R&S OSP-B103 module is opened, the actual output pattern setting of this module is read back from the hardware and displayed.

I/O ports

Note that for I/O ports the hardware specification must be observed when connecting external equipment. See chapter 8.4 in the operating manual for further information.

3.3.8.2 Reading the Input Pattern

The input pattern of the R&S OSP-B103 can be read by one click.

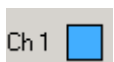
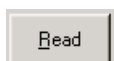

1. Pressing this button reads the input pattern of the R&S OSP-B103. The status of each input now is displayed in the input pattern field (Ch1 to Ch16). The hexadecimal representation of the input pattern is displayed in the R&S OSP-B103 dialog, too. Ch1 corresponds to the lowest bit, having the value 1, whereas Ch16 is the highest bit, having the value 8000.
2. An input channel marked in blue color indicates that the input channel reads high level.

Ch 1

- An input channel marked in white color indicates that the input channel reads low level.



R&S OSP-B103 dialog

When the dialog for operation of the R&S OSP-B103 module is opened, the actual input pattern of this module is read back from the hardware and displayed.

The module R&S OSP-B158 is similar to the R&S OSP-B103 module. For controlling this module, see chapter 3.3.8.

The R&S OSP-B158 module contains a checkbox *Display AU600 panel design*. After selecting the checkbox, the user is prompted to close the actual panel and to open it again. After opening the R&S OSP-B158 panel again, a special interface for controlling the AU600 antenna system appears.

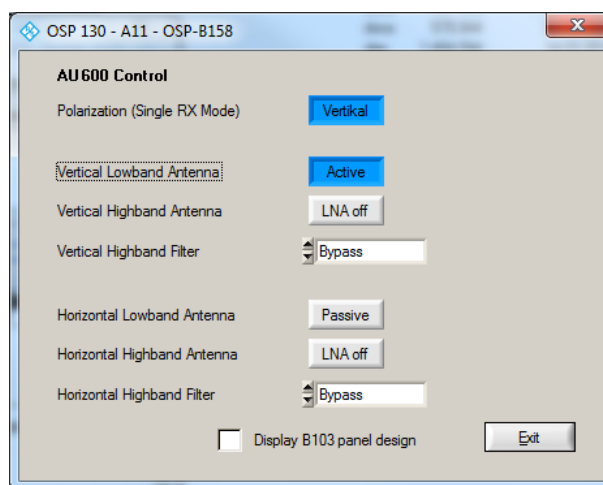

Figure 3-1: AU600 panel design



AU600 panel design

The special AU600 panel design is explained in detail in the R&S AU600 manual.

3.3.9 Controlling the R&S OSP-B104/-B114

After selection of the R&S OSP-B104 module the following dialog is opened.

The module R&S OSP-B104 contains control for up to four external power relays. Furthermore, five output lines and four input lines of I/O ports are available, and there is some specific interlock functionality. The R&S OSP-B104 dialog shows all these elements:

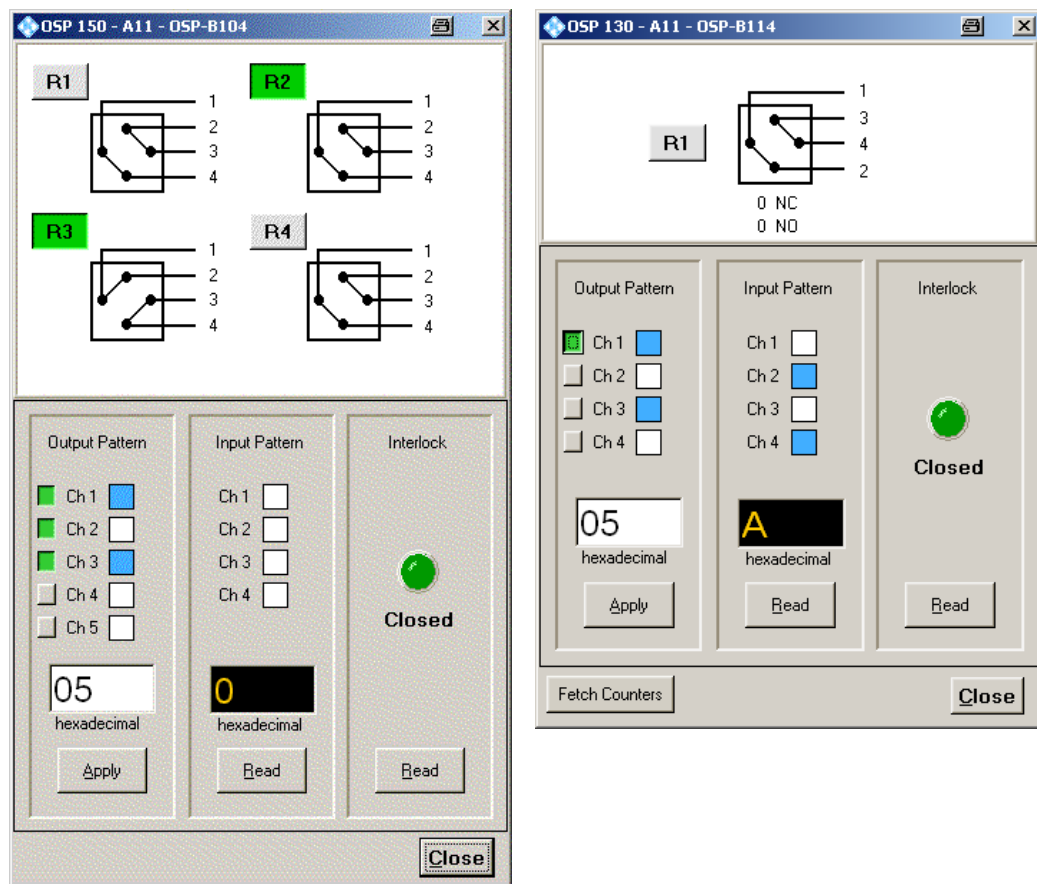

See also chapter 9.2.4 in the operating manual for a detailed description of the interface.

The module R&S OSP-B114 only contains one built-in DPDT relay and offers four output lines. The other functions are the same as for the R&S OSP-B104 module.

3.3.9.1 Setting the Transfer Relays

Clicking to the symbol of the relay, the position of each relay can be toggled individually. In one position the connections are made between connectors 1 and 2 and between 3 and 4. In the other position the connections are made between connectors 1 and 4 and between 2 and 3.

The buttons R1 up to R4 are not required for manual operation of the switches, but for defining a path configuration (see chapter 3.4).

R1

Any button R1 up to R4 in grey color indicates that this relay is not selected. A non selected relay is not considered when defining a path configuration.

R2

To take over particular relays into the path configuration, the relay buttons must be selected by clicking on each of the relay buttons required. The selected relay is displayed with a button in green color. All relays whose relay buttons are selected are taken over into a path configuration.

Pressing the Shift key while clicking on a relay button will toggle between selecting all relays of this module and deselecting all of them.

R&S OSP-B104/-B114 dialog



When the dialog for operation of the R&S OSP-B104 module is opened, the actual relay setting of this module is read back from the hardware and displayed. The information from the relay status is used, therefore also manual operation of the relay is recognized.

As mentioned above, the actual status of the relays is read back from the relays itself via an additional contact (position contact). If this contact is not wired or does not close, the “faulty” status of a relay is marked by a red field at the relay number concerned. See following example.

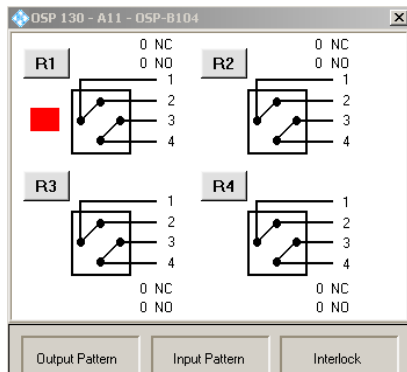

R&S OSP-B104 relay status / delay time



The LAN configuration can be setup using the OSP Panel application. Seeback of the relay status on the R&S OSP-B104 fails and is marked by a red field, the relay position contact and/or cabling needs to be checked.

Note that the R&S OSP-B104 relay delay time must be set in accordance to the relay data specification. If the delay time is too short, the relay status also may be shown as faulty. See chapter 5.2.4 for further information on the relay delay time.

3.3.9.2 Setting the Output Pattern

Clicking on one of the channel buttons in the output pattern field, the status of the output channel can be changed.

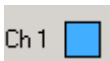

An output channel marked in blue color indicates that the output channel is switched to low level (GND). Switching is performed on an active low signal, therefore the blue color indicates the active state.

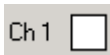

An output channel marked in white color indicates, that the output channel is in high impedance state. This is also the default after reset.

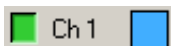

To take over particular channels of the output port into the path configuration, the button left to the channels of the output pattern must be selected by clicking on each button of the required outputs. The selected output channel is displayed in green color. All output ports with selected (green) buttons are taken over into a path configuration. Pressing the Shift key while clicking on a relay button will toggle between selecting all relays of this module and deselecting all of them.

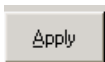

Pressing this button sets the R&S OSP-B104 outputs to the defined output pattern. The actual setting of the R&S OSP-B104 outputs now is displayed in the output pattern field (Ch1 to Ch5).

The hexadecimal representation of the output pattern is displayed in the R&S OSP-B105 dialog, too. Ch1 corresponds to the lowest bit, having the value 1, whereas Ch5 is the highest bit, having the value 10.



R&S OSP-B104/-B114 dialog

When the dialog for operation of the R&S OSP-B104 module is opened, the actual output pattern setting of this module is read back from the hardware and displayed.

I/O ports

Note that for I/O ports the hardware specification must be observed when connecting external equipment. See chapter 8.4 in the operating manual for further information

3.3.9.3 Reading the Input Pattern

The input pattern of the R&S OSP-B104/-B114 can be read by one click.

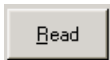

1. Pressing this button reads the input pattern of the R&S OSP-B104. The status of each input now is displayed in the input pattern field (Ch1 to Ch4). The hexadecimal representation of the input pattern is displayed in the R&S OSP-B104 dialog, too. Ch1 corresponds to the lowest bit, having the value 1, whereas Ch4 is the highest bit, having the value 8.

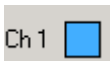

2. An input channel marked in blue color indicates that the input channel reads high level.



3. An input channel marked in white color indicates that the input channel reads low level.



R&S OSP-B104/-B114 dialog

When the dialog for operation of the R&S OSP-B104 module is opened, the actual input pattern of this module is read back from the hardware and displayed.

3.3.9.4 Reading the Interlock State

The interlock state of the R&S OSP-B104 can be read by one click.

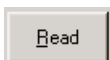

Pressing this button reads the interlock state of the R&S OSP-B104

The status of the interlock, i.e. if there is a connection between pins 7 and 15 of the IN / OUT connector, is indicated. A green signal shows a closed interlock, a red signal an open interlock. If the interlock is closed, a relay also closes a contact between pins 8 and 14 of the IN / OUT connector.



R&S OSP-B104/-B114 dialog

When the dialog for operation of the R&S OSP-B104 module is opened, the actual interlock status is read back from the hardware and displayed.

3.3.10 Controlling the R&S OSP-B108

After selection of the R&S OSP-B108 module the following dialog is opened.

The module R&S OSP-B108 contains one switches of 4P6T type, which is shown in the R&S OSP-B108 dialog.

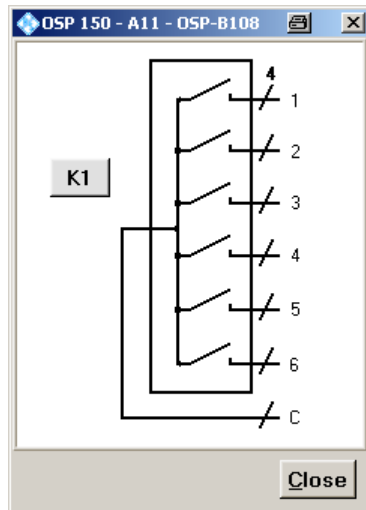

Clicking on any of the six positions this relay will switch to the associated terminal. Clicking on a closed position will open it and reset this relay.



4P6T switch

Note that for this type of relay only one terminal (1 of 6) can be activated at the same time. If no terminal is activated, the relay is in open position.

The buttons K1 is not required for manual operation of the switches, but for defining a path configuration (see chapter 3.4).

K1

A button K1 and/or K2 in grey color indicates that this relay is not selected. A non selected relay is not considered when defining a path configuration.

K1

To take over particular relays into the path configuration, the relay buttons must be selected by clicking on each of the relay buttons required. The selected relay is displayed with a button in green color. All relays whose relay buttons are selected are taken over into a path configuration.

Pressing the Shift key while clicking on a relay button will toggle between selecting all relays of this module and deselecting all of them.



R&S OSP-B108 dialog

When the dialog for operation of the R&S OSP-B108 module is opened, the actual relay setting of this module is read back from the hardware and displayed.

3.3.11 Controlling the R&S OSP-B131

After selection of the R&S OSP-B131 module the following dialog is opened.

The module R&S OSP-B131 contains two SPDT relays.

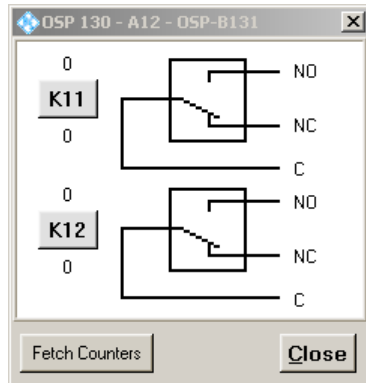

Clicking to the symbol of the relay, the position of each relay can be toggled individually.

SPDT switch



Note that the terminal NC assigns the Normally Closed position. When the relay is not activated, terminal NC is connected to terminal C.

The terminal NO is the Normally Open position. If the relay is activated, the terminal NO is connected to terminal C.

The buttons K11 and K12 are not required for manual operation of the switches, but for defining a path configuration (see chapter 3.4).

K12

Any button K11 and/or K12 in grey color indicates that this relay is not selected. A non selected relay is not considered when defining a path configuration.

K11

To take over particular relays into the path configuration, the relay buttons must be selected by clicking on each of the relay buttons required. The selected relay is displayed with a button in green color. All relays whose relay buttons are selected are taken over into a path configuration.

Pressing the Shift key while clicking on a relay button will toggle between selecting all relays of this module and deselecting all of them.



R&S OSP-B131 dialog

When the dialog for operation of the R&S OSP-B131 module is opened, the actual relay setting of this module is read back from the hardware and displayed.

3.3.12 Controlling the R&S OSP-B116/-B136

After selection of the R&S OSP-B116 and OSP-B136 module, respectively, one of the following dialogs is opened.

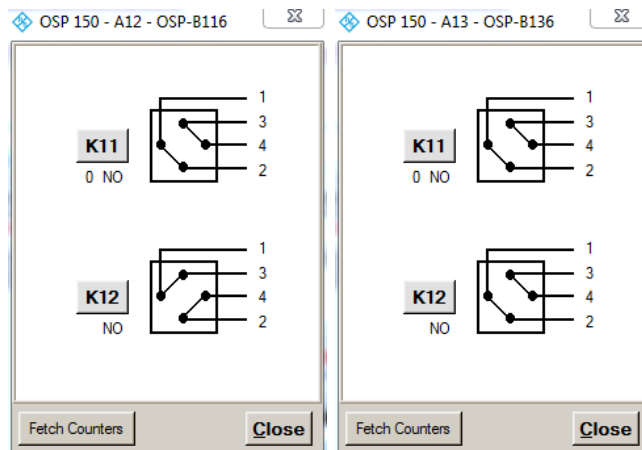

The modules R&S OSP-B116 and R&S OSP-B136 contain two DPDT relays.

Clicking to the symbol of the relay, the position of each relay can be toggled individually.

DPDT switch



When the relay is not activated, terminals 1 - 2 and 3 - 4 are connected. This is the reset (power on) condition as well. If the relay is activated, the terminal 1 - 3 and 2 - 4 are connected.

The buttons K11 and K12 are not required for manual operation of the switches, but for defining a path configuration (see chapter 3.4).

K12

Any button K11 and/or K12 in grey color indicates that this relay is not selected. A non selected relay is not considered when defining a path configuration.

K11

To take over particular relays into the path configuration, the relay buttons must be selected by clicking on each of the relay buttons required. The selected relay is displayed with a button in green color. All relays whose relay buttons are selected are taken over into a path configuration. Pressing the Shift key while clicking on a relay button will toggle between selecting all relays of this module and deselecting all of them.

3.3.13 Controlling the R&S OSP-B142

After selection of the R&S OSP-B142 module the following dialog is opened.

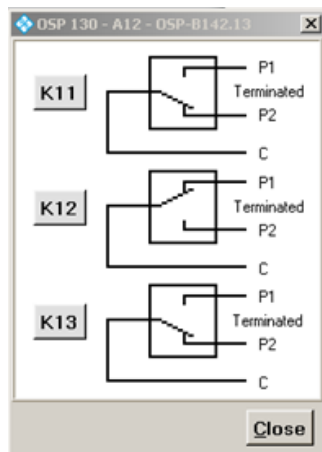

The module R&S OSP-B142 contains a maximum of three SPDT relays.

Clicking to the symbol of the relay, the position of each relay can be toggled individually.



SPDT switch

When the relay is not activated, port C is connected to port P2. This is the reset (power on) condition as well. When the relay is activated, port C is connected to port P1.

The buttons K11, K12 and K13 are not required for manual operation of the switches, but for defining a path configuration (see chapter 3.4).

K12

Any button K11, K12 or K13 in grey color indicates that this relay is not selected. A non-selected relay is not considered when defining a path configuration.

K11

To take over particular relays into the path configuration, the relay buttons must be selected by clicking on each of the required relay buttons. The selected relay is displayed with a button in green color. All relays whose relay buttons are selected are taken over into a path configuration.

Pressing the Shift key while clicking on a relay button will toggle between selecting all relays of this module and deselecting all of them.

3.4 Path Configuration

A very comfortable way to define the different switching paths required in a test setup or in a system is the R&S OSP feature “path configuration”. This utility allows to combine several relay positions of different R&S OSP modules in one path information. The path can be named with a suitable name. If path switching is required, only the path configuration is called by its name and the switching is performed more or less by a single command.

The advantage to make use of the R&S OSP path configuration utility is:

The switching is called by logical name from the external application (for example EMC32 software). Using the logical name, the external application does not need to know the R&S OSP hardware configuration.

If the hardware configuration changes, it is sufficient to adapt the path configuration inside the R&S OSP. The external application does not need to be changed.

Choosing a default selection



To obtain the correct switching for a new path configuration, it is recommended to start with a well-defined default selection. There are two possibilities:

If the number of switches to be included in a path is rather small, it is recommended to deselect all switches. This is done by >Configure >Deselect all Switches.

If the number of switches is rather large, use >Configure >Select all Switches instead. Don't forget to select / deselect all switches which are not correctly selected by this default selection.

3.4.1 Save a Path

The path configuration is supported by the OSP Panel application. Refer to chapters 3.2 and 3.3 for the installation and operation of the OSP Panel.

To have a defined condition for the path switching, it is recommended to start with the R&S OSP in Reset condition.

A path configuration may consist out of several relays located on different R&S OSP modules. Please note that the relay buttons in the corresponding dialogs must be selected for all relays which should be taken over in the path configuration.

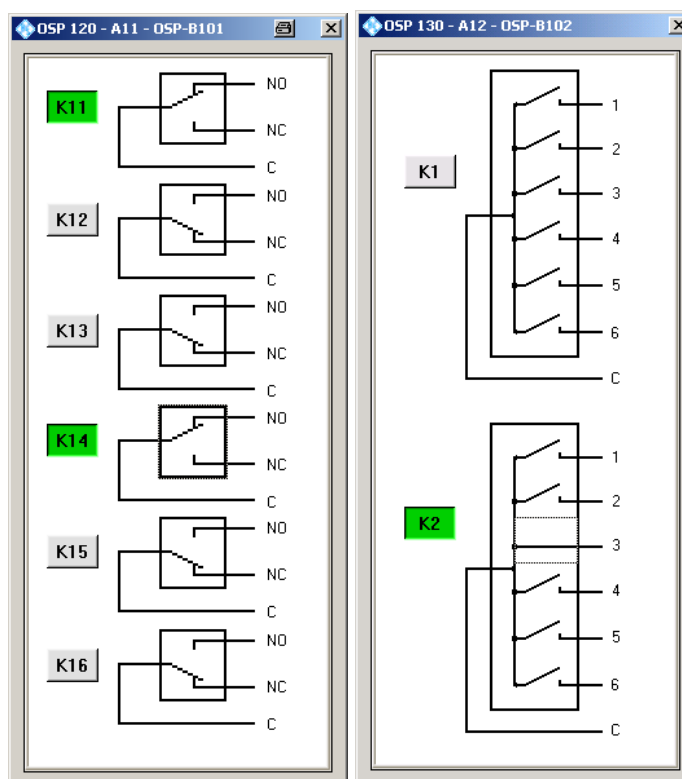

In the above example, the relays K11 and K14 from module R&S OSP-B101 and the relay K2 from module R&S OSP-B102 will be saved as a path.

To define and save the path, proceed as follows:

1. Select >Path >Save Path ... in the OSP Panel.

The following dialog will appear:

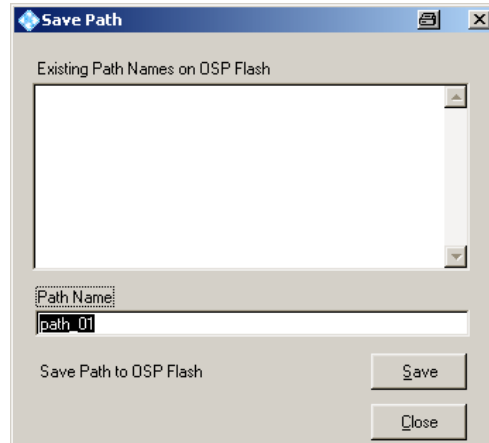

The path configuration is named by default to “path_01”. A new name for the path configuration can be entered by overwriting the default name.

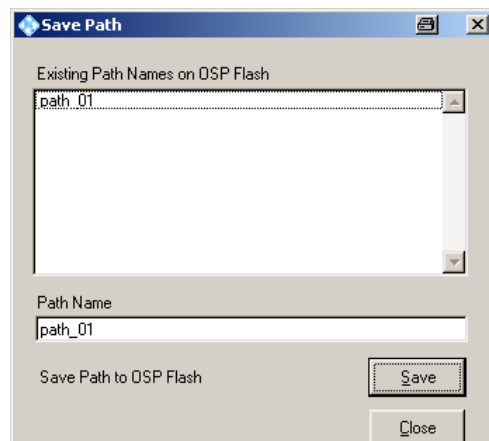

2. Pressing the button Save saves the path in the flash memory of the R&S OSP. The upper data field shows the existing paths which already are stored in the R&S OSP flash memory.
3. Takes over the actual switching into the path and stores the path in the R&S OSP.

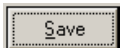

Invalid path configurations

When changing the hardware configuration of an R&S OSP it may happen that a previously stored path no longer is applicable. For example, moving a module to a neighboring position and leaving the previous position empty will make all references to this slot invalid.

Whenever the OSP Panel encounters such an invalid path, it will display some warning message, and in addition the path name will be displayed in blue, giving some bare information about the included switches.

3.4.2 Switch a Path

If a path has been defined as described in the previous chapter, the path can be switched as follows:

1. Start the OSP Panel.
2. Select >Path >Switch Path ... in the OSP Panel.

The following dialog appears:

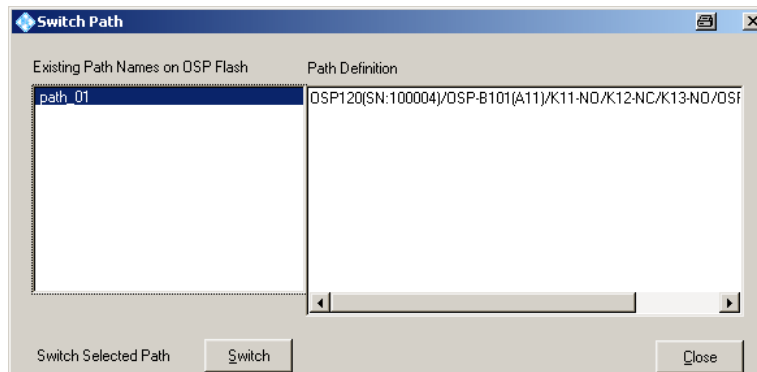

The left field shows the names of all path configurations which already have been defined. The highlighted path configuration will be switched when pressing the Switch button.

The right field Path Definition shows all relays and settings related to the selected path.

The selected path configuration will be switched; i.e. all the relays and outputs, respectively, which are part of the path, will be set to the defined position.

Pressing this button will exit the dialog

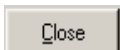
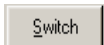

3.4.3 Delete a Path

If a path has been defined as described in the previous chapter, the path can be deleted as follows:

1. Start the OSP Panel.
2. Select >Path >Delete Path ... in the OSP Panel.

The following dialog appears:

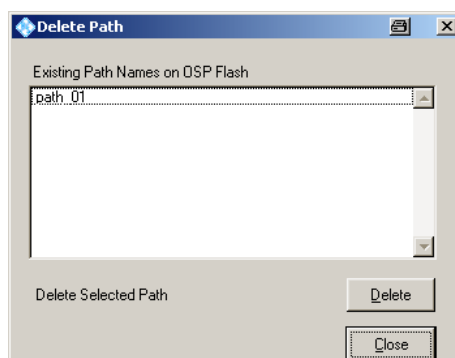

The field shows the names of all paths which already have been defined. The highlighted path configuration will be deleted when pressing the Delete button.



The selected path will be deleted from the flash memory in the R&S OSP. The only possibility to recover a path which was unintentionally deleted is to use the Import Path function, assuming the path has been exported before.

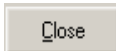

Pressing this button will exit the dialog

3.4.4 Export a Path

If a path has been defined as described in the previous chapter, the path can be exported to a file as follows:

1. Start the OSP Panel.
2. Select >Path >Export Paths ... in the OSP Panel.

The following dialog appears:

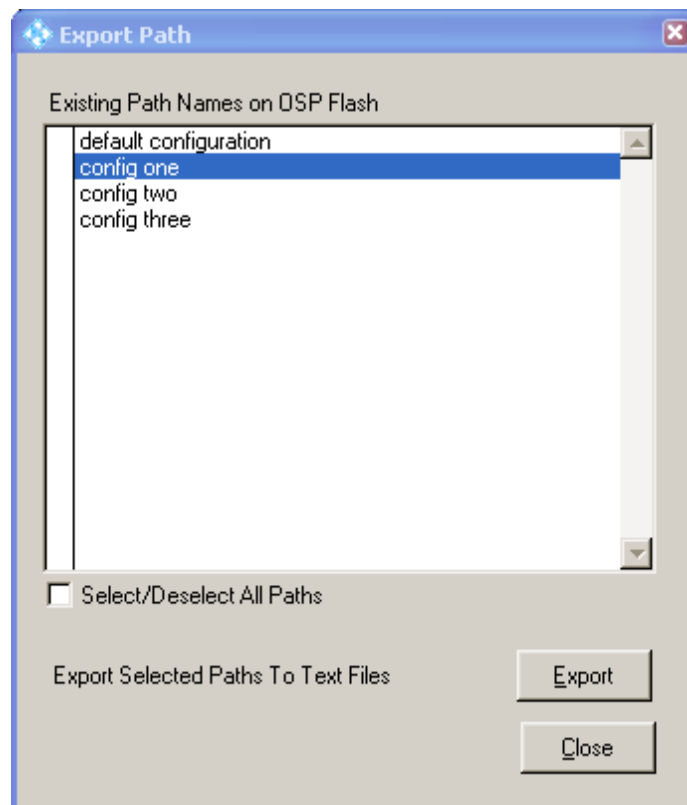

The list of path names contains all paths stored on the flash memory of the R&S OSP. A tick in the leftmost column indicates which paths are currently selected in this dialog. Clicking into a line toggles selection and deselection of the path. By activating the check box below the list all paths can be selected or deselected at once.

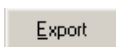

End of path selection, go to the following dialog.

Close

Pressing this button will exit the dialog.

In the next dialog the directory is chosen where the files containing the path information are created.

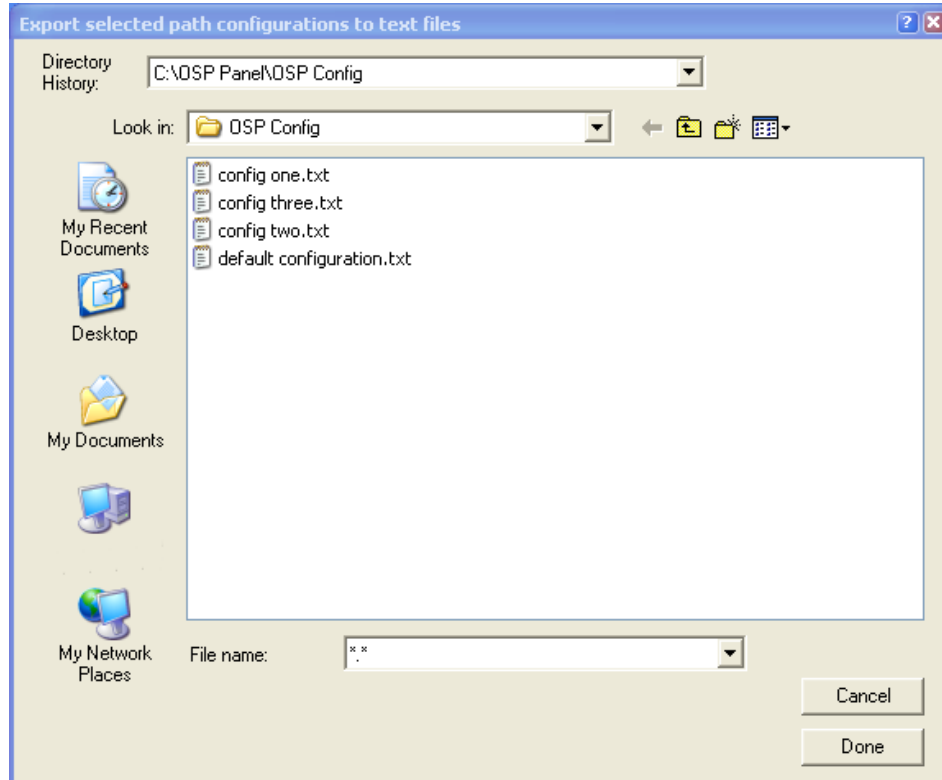

With the usual Windows operation one can move throughout the files system in order to define the directory. By default the directory is the installation path of the OSP Panel.

The file name selection in the lower part of the dialog has no meaning. Only the directory name in the field at the top of the dialog is used.

Done

The selected paths will be saved as files with the suffix ".txt" to the directory indicated.

Cancel

Pressing this button will exit the dialog

3.4.5 Import a Path

If a path has been exported as described in the previous chapter, the path can be imported again. It is required that the OSP Panel is connected to an instrument.

1. Start the OSP Panel.
2. Select >Path >Import Paths ... in the OSP Panel.

The following dialog appears:

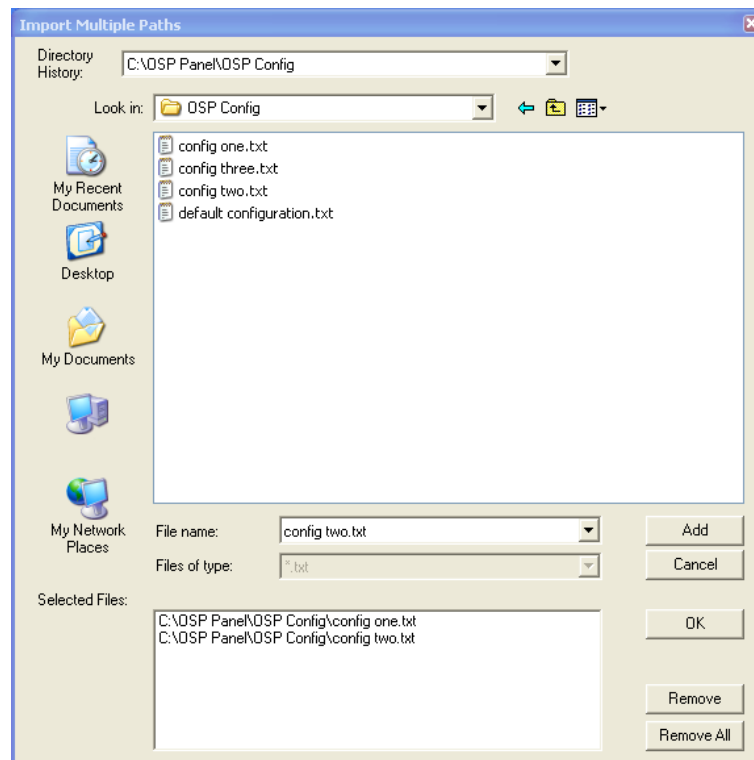

This dialog allows to select all files which shall be imported and saved on the R&S OSP. Once all required files are collected, pressing the OK button will start the import.

Add

Pressing the Add button moves the marked file to the list of selected files. With the standard Windows function a group of files can be selected at once: using the Shift key while clicking on a second file will mark all files between a first file and this one, and using the Ctrl key at the same time will add the second file as a marked one.

Cancel

Will exit the dialog

OK

The selected files will be imported and stored as paths to the R&S OSP flash memory.

Remove

The marked file will be removed from the list of selected files.

Remove All

All files will be removed from the list of selected files.

3.5 Sample Session

The sample session shows a typical application of the R&S OSP and gives a guidance to the user how to solve the various switching tasks with the R&S OSP.

3.5.1 Example Path Configuration

The following example shows how to set up the path for a Microwave EMS system up to 18 GHz consisting of a signal generator, three amplifiers and a two-channel power meter. The following signal paths are required and have to be set dependent on the frequency range.

- Generator output to amplifier input
- Amplifier output forward power to power meter
- Amplifier output reverse power to power meter

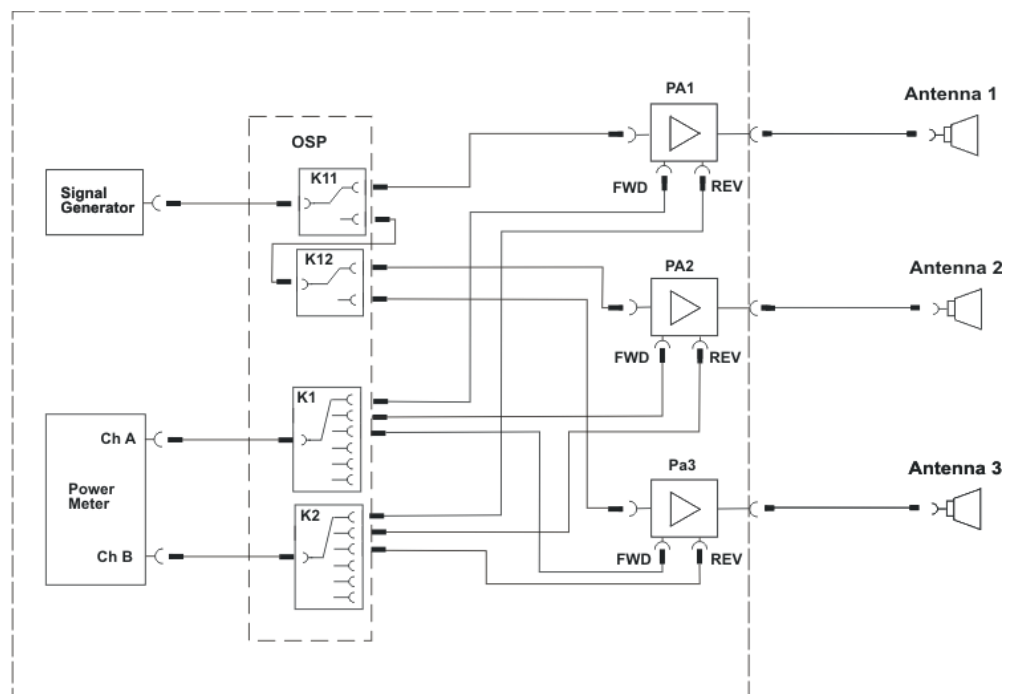

3.5.1.1 Defining the Path for PA1

To have a defined condition for the path switching, it is recommended to start with the R&S OSP in Reset condition.



Reset

To obtain the correct switching for a new path configuration, it is recommended to reset the R&S OSP. Select in the OSP Panel >Configure >Deselect all Switches.

According to the above example, for amplifier PA1 the following paths are required:

Signal path	Required relay position
Sig Gen to PA1 input	R&S OSP-B101 / K11- NO
PA1 Fwd to Power Meter Ch A	R&S OSP-B102 / K1-1
PA1 Fwd to Power Meter Ch B	R&S OSP-B102 / K2-1

Start the OSP Panel and make sure not to take over any undesired relay setting. Select therefore in the OSP Panel >Configure >Deselect all Switches.

After that, select the R&S OSP-B101 dialog and set K11 to position NO. Do not forget to select the K11 button.

Now select the R&S OSP-B102 dialog and set K1 and K2 to position 1. Do not forget to select the K1 and K2 buttons.

Now start the path configuration as follows:

- ▶ Select >Path >Save Path ... in the OSP Panel.

The following dialog will appear:

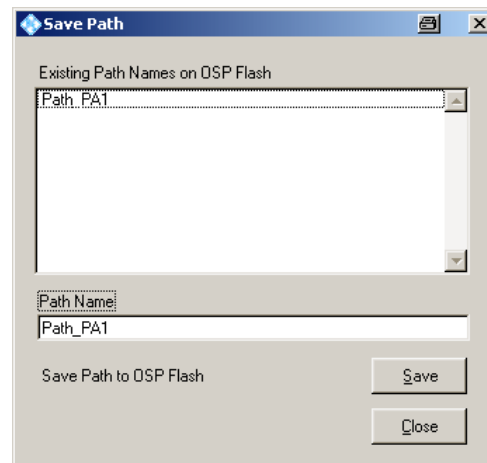

The upper data field shows the paths which are already stored in the R&S OSP. Type in the path name "Path_PA1" and press the button "Save".

3.5.1.2 Defining the Path for PA2

According to the above example, for amplifier PA2 the following paths are required:

Signal path	Required relay position
Sig Gen to PA2 input	R&S OSP-B101 / K11- NC, K12-NO
PA2 Fwd to Power Meter Ch A	R&S OSP-B102 / K1-2
PA2 Fwd to Power Meter Ch B	R&S OSP-B102 / K2-2

Start the OSP Panel and make sure not to take over any undesired relay setting. Select therefore in the OSP Panel >Configure >Deselect all Switches.

After that, select the R&S OSP-B101 dialog and set K11 to position NC and K12 to position NO. Do not forget to select the K11 and K12 buttons.

Now select the R&S OSP-B102 dialog and set K1 and K2 to position 2. Do not forget to select the K1 and K2 buttons.

Now start the path configuration as follows:

Select >Path >Save Path ... in the OSP Panel.

The following dialog will appear:

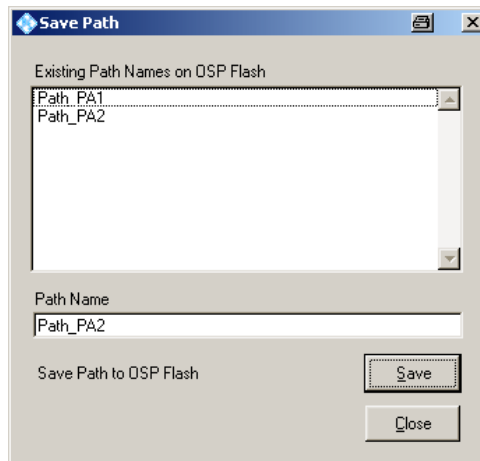

The upper data field shows the paths which are already stored in the R&S OSP. Type in the path name "Path_PA2" and press the button "Save".

3.5.1.3 Defining the path for PA3

According to the above example, for amplifier PA3 the following paths are required:

Signal path	Required relay position
Sig Gen to PA3 input	R&S OSP-B101 / K11- NC, K12-NC
PA3 Fwd to Power Meter Ch A	R&S OSP-B102 / K1-3
PA3 Fwd to Power Meter Ch B	R&S OSP-B102 / K2-3

Start the OSP Panel and make sure not to take over any undesired relay setting. Select therefore in the OSP Panel >Configure >Deselect all Switches.

After that, select the R&S OSP-B101 dialog and set K11 to position NC and K12 to position NC. Do not forget to select the K11 and K12 buttons.

Now select the R&S OSP-B102 dialog and set K1 and K2 to position 3. Do not forget to select the K1 and K2 buttons.

Now start the path configuration as follows:

Select >Path >Save Path ... in the OSP Panel.

The following dialog will appear:

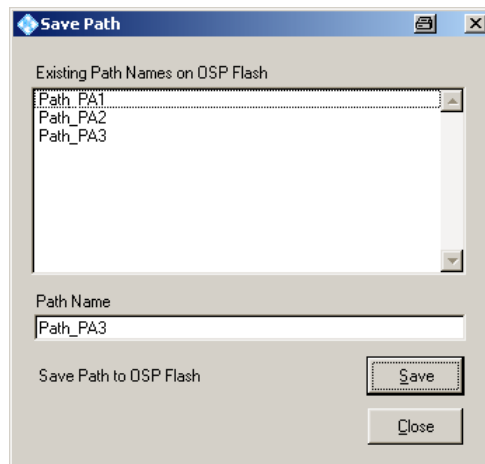

The upper data field shows the paths which are already stored in the R&S OSP. Type in the path name “Path_PA3” and press the button “Save”.

The path configuration now is stored in the R&S OSP flash memory and is available for further use.

3.5.2 Manual Setting of the Paths

To set up the path for power amplifier PA 1, PA2 and PA3, respectively, only a simple step is required.

Select >Path >Switch Path ... in the OSP Panel.

The following dialog appears:

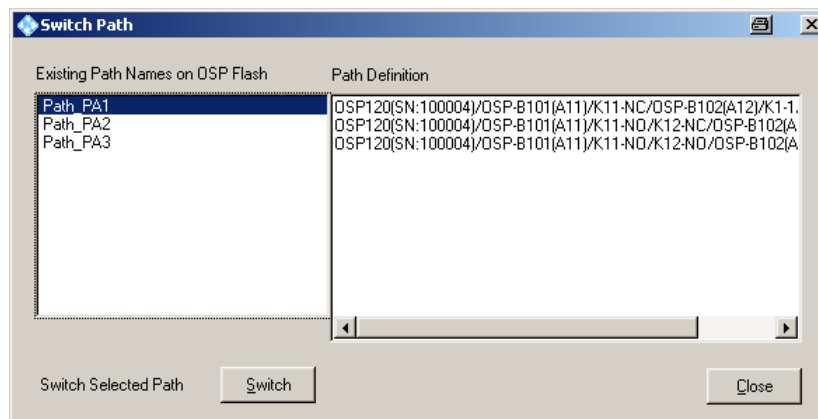

Select the path name Path_PA1, press the button “Switch” and all necessary switching for PA1 is done.

For PA2 and PA3 proceed accordingly.

The field Path Definition shows the relay setting of the selected path.

The path definition also is shown in the OSP Panel system information.

Select >File >System Info ... in the OSP Panel. For the above example, the following information is shown:

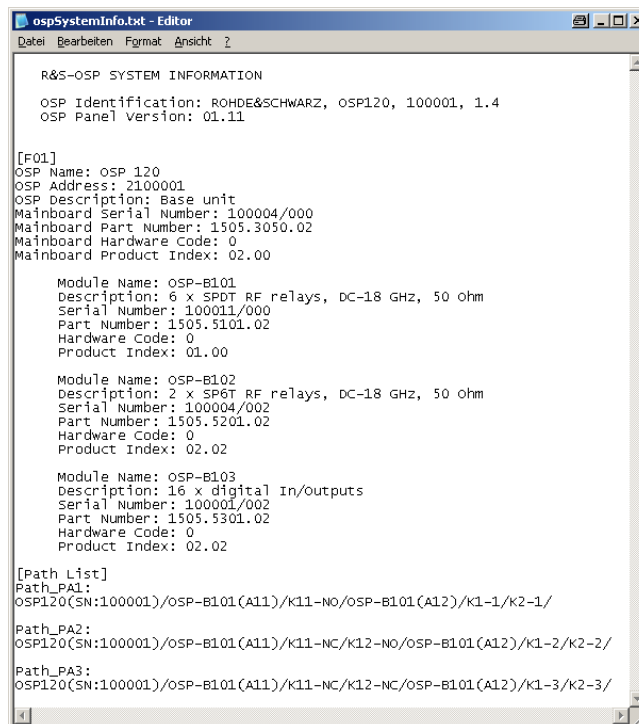

```

ospSystemInfo.txt - Editor
Datei Bearbeiten Format Ansicht ?

R&S-OSP SYSTEM INFORMATION

OSP Identification: ROHDE&SCHWARZ, OSP120, 100001, 1.4
OSP Panel version: 01.11

[F01]
OSP Name: OSP 120
OSP Address: 2100001
OSP Description: Base unit
Mainboard Serial Number: 100004/000
Mainboard Part Number: 1505.3050.02
Mainboard Hardware Code: 0
Mainboard Product Index: 02.00

Module Name: OSP-B101
Description: 6 x SPDT RF relays, DC-18 GHz, 50 ohm
Serial Number: 100011/000
Part Number: 1505.5101.02
Hardware Code: 0
Product Index: 01.00

Module Name: OSP-B102
Description: 2 x SP6T RF relays, DC-18 GHz, 50 ohm
Serial Number: 100004/002
Part Number: 1505.5201.02
Hardware Code: 0
Product Index: 02.02

Module Name: OSP-B103
Description: 16 x digital In/outputs
Serial Number: 100001/002
Part Number: 1505.5301.02
Hardware Code: 0
Product Index: 02.02

[Path List]
Path_PA1:
OSP120(SN:100001)/OSP-B101(A11)/K11-NO/OSP-B101(A12)/K1-1/K2-1/

Path_PA2:
OSP120(SN:100001)/OSP-B101(A11)/K11-NC/K12-NO/OSP-B101(A12)/K1-2/K2-2/

Path_PA3:
OSP120(SN:100001)/OSP-B101(A11)/K11-NC/K12-NC/OSP-B101(A12)/K1-3/K2-3/

```

3.5.3 Remote Control Setting of the Path Configuration

Once the required path configurations are stored in the R&S OSP, they are available by remote control applications like the R&S EMC32 software.

The advantage to make use of the R&S OSP path configuration utility is:

- The switching is called by logical name from the external application (for example R&S EMC32 software). Using the logical name, the external application does not need to know the R&S OSP hardware configuration.
- If the hardware configuration has to be changed, only the path configuration inside the R&S OSP must be adapted. The external application does not need to be changed.

For the above examples, the following strings are to be sent to the R&S OSP:

```

ROUTE:CLOSE "Path_PA1"
ROUTE:CLOSE "Path_PA2"
ROUTE:CLOSE "Path_PA3"

```

Further information on remote control functions are to be found in Chapters 6 and 7 in the operating manual. Information of applications together with the R&S EMC32 software is available in chapter 8.1 in the operating manual.

4 Manual Operation

The model R&S OSP120 is the version in the R&S OSP family which is operated remote controlled. There are no keys and display on the front panel for manual control. If an R&S OSP150 is connected to this R&S OSP120, it is also controlled from there.

See next chapter for kind of manual operation.

The model R&S OSP130 is equipped with display and front panel keys for manual operation.

4.1 Manual Operation of the Modules

A “manual operation” of the instrument functions is achieved by the OSP Panel or using the graphical user interface (GUI) of the R&S OSP via Web-Browser (all models of R&S OSP family).

The model R&S OSP130 can be operated using the GUI together with the R&S OSP130 Display and keyboard.

The application OSP Panel runs on an external computer with Windows Operating System. The external computer is connected to the R&S OSP via LAN network.

See chapters 3.2 and 3.3 for installation and operation of the OSP Panel.

Information how to run the GUI via Web-Browser are provided chapter 5.3.

Details to the manual operation of the R&S OSP130 are given in chapter 5.3.

4.2 R&S OSP Setups

All setups which are necessary to perform in the Linux operating system, which is integral part of the R&S OSP120 or R&S OSP130, are to be done via external keyboard and external monitor (not for R&S OSP130).

See chapter 2.7.2 and 2.7.3 of this manual how to connect these accessories.

Chapter 2.10 gives an example for Linux related actions.

5 Instrument Functions

The following chapter describes the instrument functions of the R&S OSP. The basic instrument R&S OSP is the Platform for Switching and Control Purpose which is completed by several options. The function of the instrument depends on the options (R&S OSP modules) which are fitted in the instrument.

As an overview and for better understanding of the instrument function and the configuration possibilities, the following chapter shows block diagrams of the R&S OSP.

Then there is a description of the available modules for the R&S OSP and their function.

Basic instrument functions like selftest and configuration information are described as well.

5.1 R&S OSP Instrument Frame

The R&S OSP is designed as a 19" unit with two height units. The instruments R&S OSP120 and R&S OSP130 can remotely be controlled via LAN interface.

The R&S OSP120 contains no front elements for manual operation and is therefore only to be used in remote operation.

The R&S OSP130 can operate as a stand-alone instrument thus not requiring remote control. Front panel keys and a display allow local operation. It may also be integrated in remotely controlled systems.

The R&S OSP150 is an extension of the R&S OSP120 or R&S OSP130 allowing more modules to be used. It is connected via CAN bus connected to the rear side of the R&S OSP.

The R&S OSP unit has no switching functions as long as no R&S OSP modules are installed.

Depending on the model, the R&S OSP frame unit can consist of the following blocks:

- Computer LPC8 (Low Profile Controller)
- Mainboard
- Power supply
- Interface for USB/DVI
- Front panel with function keys and a color display screen

Switching functions are added to the R&S OSP frame unit by installation of R&S OSP modules. The R&S OSP offers three slots for installation of R&S OSP modules. The modules are installed from the rear side of the instrument. A maximum of three R&S OSP modules can be configured.

5.1.1 R&S OSP Block Diagram

The following block diagram shows the main functional groups of the R&S OSP120.

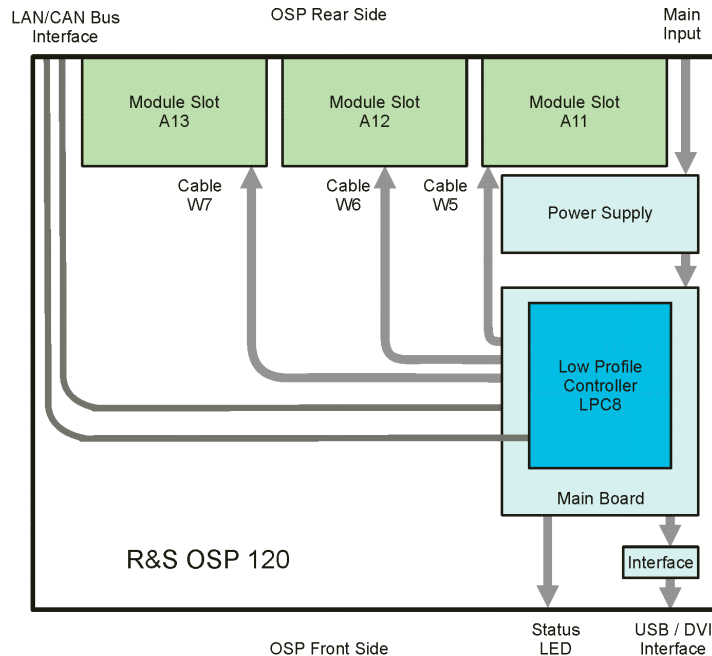

Figure 5-1: Block Diagram R&S OSP120

The central part of the R&S OSP frame is the Low Profile Controller LPC8 with Linux Operating System. The computer handles the external interfaces of the R&S OSP120 such as LAN, USB and DVI. It also serves the internal interfaces in the R&S OSP120 like the control ports for the three slots which can take the R&S OSP modules.

The single board computer is plugged onto the R&S OSP Main Board. The basic component on the mainboard is an FPGA which supplies all necessary interfaces between computer PCI Bus and R&S OSP internal interfaces like the control ports for the R&S OSP modules. The CAN bus which is used to connect further R&S OSP extension units is implemented in the FPGA as well.

The power is supplied by a 175 W switching type power supply. The supply voltage for the R&S OSP modules and their relays is generated by a voltage converter which is placed on the Main Board.

Via a small interface board the connectors of the Low Profile Controller are adapted to the standard interfaces to connect USB devices and the DVI monitor.

The next block diagram shows the main functional groups of the R&S OSP130.

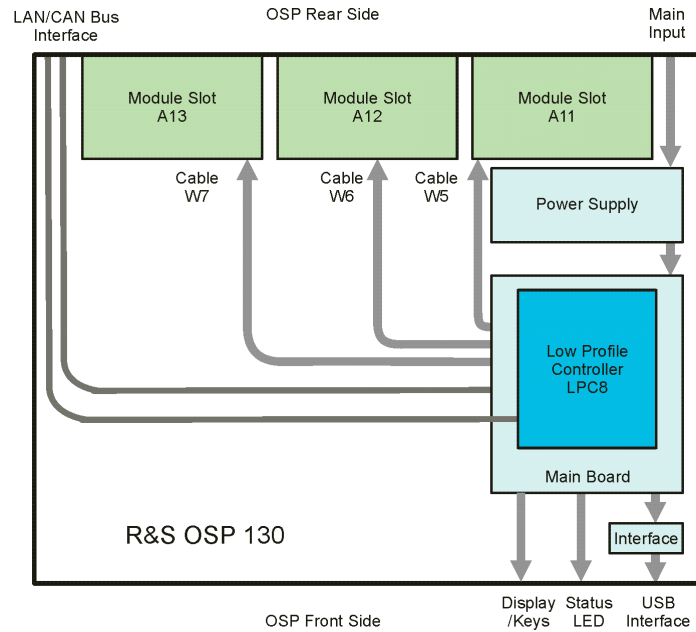

Figure 5-2: Block Diagram R&S OSP130

Additional to the R&S OSP120, in the R&S OSP130 the connection to the front side display unit and keys is available for local operation. No connection to an external monitor is available.

Finally, the block diagram of the R&S OSP150 extension unit shows its main functional blocks:

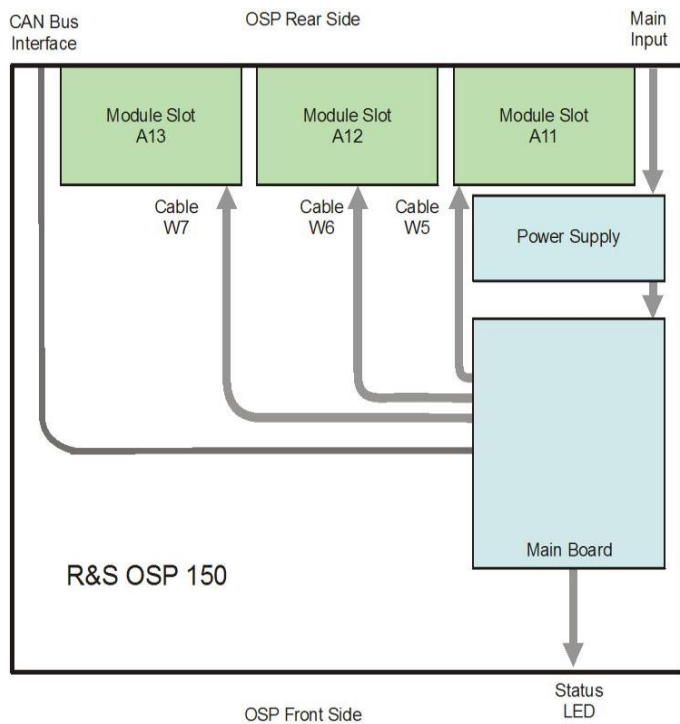

Figure 5-3: Block Diagram R&S OSP150

5.1.2 R&S OSP Module Slots

The R&S OSP offers three slots for installation of R&S OSP modules. The modules are installed from the rear side of the instrument. A maximum of three R&S OSP modules can be configured. If more R&S OSP modules are required, the R&S OSP can be extended by the version R&S OSP150. The extension unit R&S OSP150 is controlled from the R&S OSP120 or R&S OSP130 by CAN bus Interface.

Refer to chapter 8.2 in the operating manual for detailed information on the extension unit R&S OSP150.



Figure 5-4: R&S OSP Module Slots

The slots are designated with A11, A12 and A13. The same order is used when addressing the modules; i.e. R&S OSP module 1 corresponds to slot A11 etc.

In principle the R&S OSP modules can be installed in the slots in any order. A slot which is not occupied will be shown as empty by the OSP Panel application.

NOTICE

Module Slots

The depth of the module slot A11 is limited. Only modules with a depth < 70 mm like the modules R&S OSP-B101, R&S OSP-B102, R&S OSP-B103, R&S OSP-B107, R&S OSP-B111 or R&S OSP-B112 can be operated in this slot! R&S OSP-B106 can be placed in slots A11+ A12 or A12 + A13.

For installation of the modules see the corresponding installation procedures.

5.1.3 R&S OSP120 Version12 and Module Slots

The R&S OSP120 Version 12 is designed with two slots in the front side in addition to the three slots at the rear side as described above.

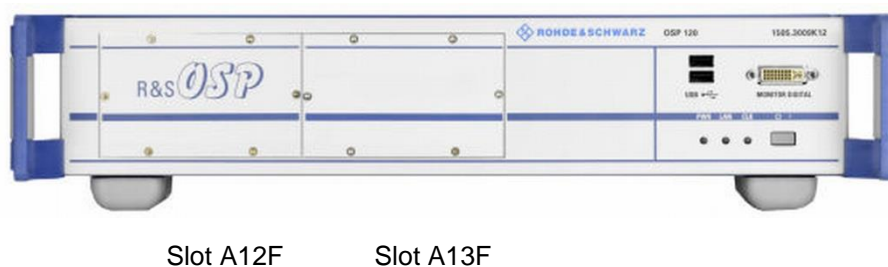

Figure 5-5: R&S OSP120 Version12 Module Slots at front side

Standard Configuration:

The slots in the front side are designated with A12F and A13F. For installation of modules, the following order is defined as standard:

The first module installed from R&S OSP front side always is mounted in slot A13F. From interface point of view it corresponds to slot A13 (connected via cable W7 – see figure below).

The second module installed from R&S OSP front side is mounted in slot A12F. From interface point of view it corresponds to slot A12 (connected via cable W6 – see figure below).

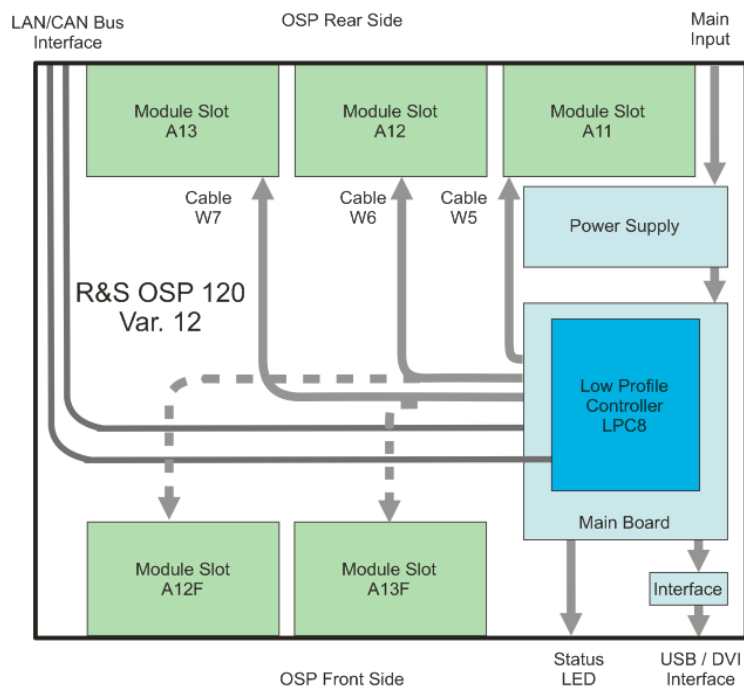

Figure 5-6: Block Diagram R&S OSP120 Var. 12

Configuration of 2-slot modules:

R&S OSP modules with 2-slot size and requiring two interface cables W6 and W7 (like the modules R&S OSP-B105/-B115/-B125/-B126) only can be mounted in A12/A13 or A12F/A13F.

That means with a 2-slot module configured in A12/A13 and one module configured in the R&S OSP front side, only interface cable W5 (corresponding to A11) is left for A13F).

5.1.4 R&S OSP120 Version12 and Modules R&S OSP-B011/-B012

Configuring a system with instruments having the RF connectors at the front panel, the cabling will be made easy having the RF connectors at the R&S OSP120 front side as

well. The R&S OSP120 Version 12 is designed with two slots in the front side of the in addition to the three slots at the rear side. Two slots therefore can be used for mounting the options R&S OSP-B011 and/or R&S OSP-B012. See following diagram.

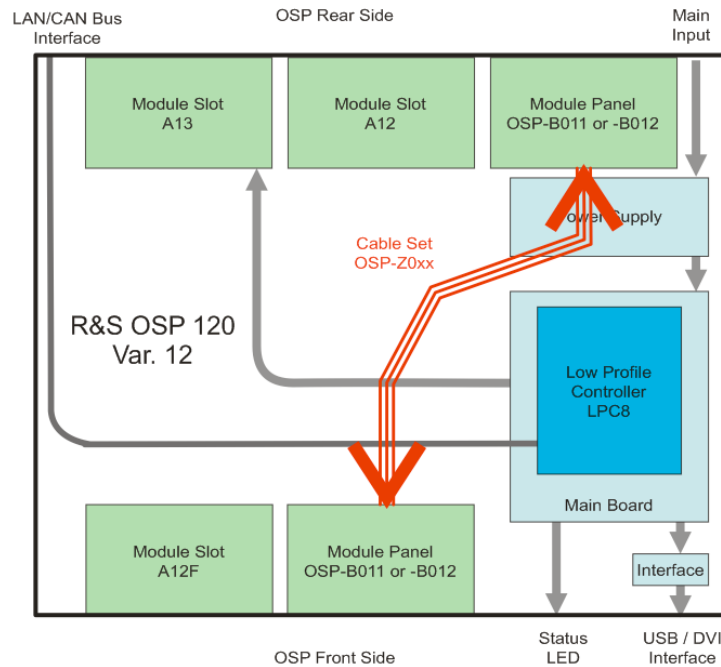

Figure 5-7: Block Diagram R&S OSP120 Var. 12

NOTICE

Installation of Module Panels R&S OSP-B011/-B012

Note that the length of the cable sets OSP-Z010/-Z011/-Z012 is limited for a maximum offset of one module only. That means if one Module Panel is mounted in the slot A13F at the OSP front side, a second Module Panel for example can be installed at the OSP rear side in any one of the three available slots (offset ≤ 1 slot).

But it is not possible to mount one Module Panel in the slot A12F at the OSP front side and a second Module Panel at the OSP rear side in slot A11 (offset > 1 slot)!

5.1.4.1 Module Panel R&S OSP-B011

The module R&S OSP-B011 is a panel (1-slot size) prepared to be fitted with up to twelve coaxial feed-through connectors SMA-female; see below picture.

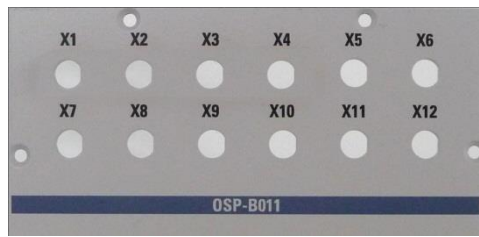

Slot A12F Slot A13F

Figure 5-8: R&S OSP-B011 module panel

For cabling the options R&S OSP-Z11 or Z12 are required. See chapter 5.1.4.3 for details.

5.1.4.2 Module R&S OSP-B012

The module R&S OSP-B012 is a panel (1-slot size) prepared to be fitted with up six coaxial feed-through connectors N-female; see below picture.

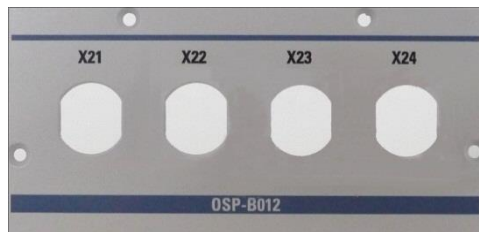

Slot A12F Slot A13F

Figure 5-9: R&S OSP-B012 module panel

For cabling the options R&S OSP-Z11 or Z12 are required. See chapter 5.1.4.3 for details.

5.1.4.3 Cable sets R&S OSP-Z010/-Z011/-Z012

The modules R&S OSP-B011 and/or R&S OSP-B012 can be connected using the cable sets and configurations as shown in the below table.

Module Panel 1	Module Panel 2	Required Cable Set	
R&S OSP-B011	R&S OSP-B011	max 3 x R&S OSP-Z010	
R&S OSP-B012	R&S OSP-B011	R&S OSP-Z011	



All Cable Sets consist out of four coaxial cables fitted with suitable coaxial connectors. The coaxial connectors are bulkhead connector types with round flange. They are fed through the Module panels from rear-side and fixed with the central screw.

This way it is not required to open the R&S OSP instrument to mount the options R&S OSP-B010/-B011 and/or -B012 together with the related cable sets.

5.1.5 R&S OSP150 Version15 and Module Slots

The R&S OSP150 Version 15 is designed with two slots in the front side in addition to the three slots at the rear side as described above.

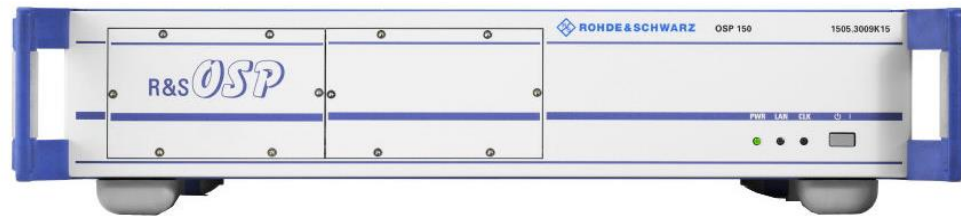

Slot A12F Slot A13F

Figure 5-10: R&S OSP150 Version15 Module Slots at front side

Standard Configuration:

The slots in the front side are designated with A12F and A13F. For installation of modules, the following order is defined as standard:

The first module installed from R&S OSP front side always is mounted in slot A13F. From interface point of view it corresponds to slot A13 (connected via cable W7 – see figure below).

The second module installed from R&S OSP front side is mounted in slot A12F. From interface point of view it corresponds to slot A12 (connected via cable W6 – see figure below).

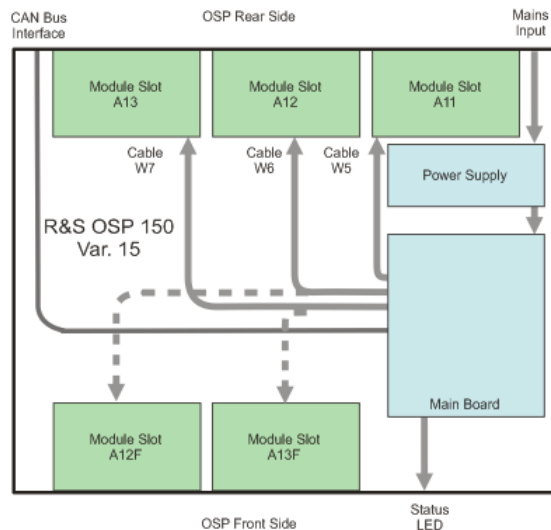

Figure 5-11: Block Diagram R&S OSP150 Var. 15

Configuration of 2-slot modules:

R&S OSP modules with 2-slot size and requiring two interface cables W6 and W7 (like the modules R&S OSP-B105/-B115/-B125/-B126) only can be mounted in A12/A13 or A12F/A13F.

That means with a 2-slot module configured in A12/A13 and one module configured in the R&S OSP front side, only interface cable W5 (corresponding to A11) is left for A13F).

5.1.6 R&S OSP150 Version15 and Modules OSP-B011/-B012

Configuring a system with instruments having the RF connectors at the front panel, the cabling will be made easy having the RF connectors at the R&S OSP150 front side as well.

For configuration and cabling of the modules R&S OSP-B011 and R&S OSP-B012 see chapter 5.1.4.

5.2 Module Functions

As already mentioned, the switching capability is added to the R&S OSP by installation of an R&S OSP module. For the different kind of switching applications, a series of R&S OSP modules is available.

The following chapters describe the function of the R&S OSP modules.

5.2.1 RF Switch Module R&S OSP-B101/-B107/-B111/-B127

The module R&S OSP-B101 and similar as listed above consists of six SPDT switches. All six switches can be operated independently from each other.

The relay is a failsafe type; i.e. an RF connection is provided from the terminal C (Common) to the position NC (normally closed) with no voltage applied to the relay. To maintain an RF connection between the terminal C (Common) and the position NO (normally open), a continuous voltage is to be applied to the relay.



Figure 5-12: Module R&S OSP-B101

The relays are mounted directly in the R&S OSP-B101 front panel. All the RF connectors are SMA female types. All relays are soldered into a printed circuit board; this way the module is of compact size and no cabling to the relays is required.

The R&S OSP-B101 module is supplied and controlled from the R&S OSP via a single connector on the R&S OSP-B101 printed circuit board. The connection to the R&S OSP is done via a single connection cable.

The R&S OSP-B101 module is equipped with an on-board memory to store the necessary configuration data of the module.

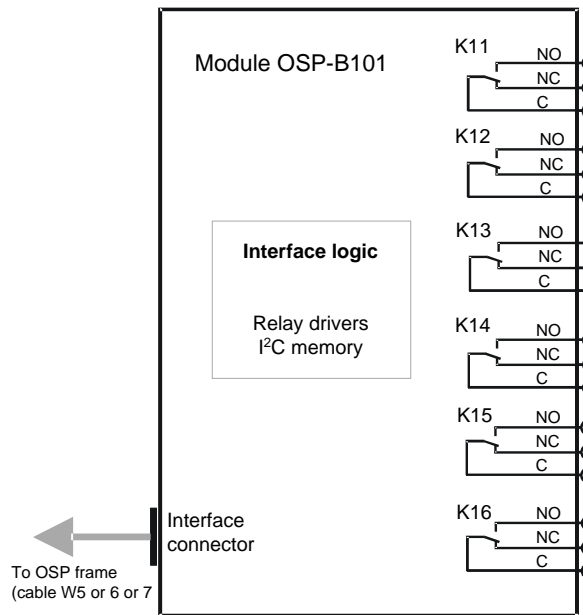

Figure 5-13: Block Diagram Module R&S OSP-B101

When the module R&S OSP-B101 is configured within the R&S OSP, a manual operation of the module can be performed via the OSP Panel. See chapter 3.3.6 for details.

For remote control operation see chapters 6 and 7 in the operating manual.

Depending on the required switching application, several modules of the R&S OSP-B101 type can be installed in one R&S OSP.

In the R&S OSP frame a maximum of three modules is possible. If more than three modules are required, the extension unit R&S OSP150 must be used. For further information on the extension unit R&S OSP150 see chapter 8.2 in the operating manual.

The description above applies to further options of the R&S OSP as far as the option has got a similar relay configuration. It will apply to the following modules:

Option	Relay configuration
R&S OSP-B107	6 x SPDT relay, solid state, 6 GHz
R&S OSP-B111	6 x SPDT relay, 40 GHz
R&S OSP-B127	6 x SPDT relay, solid state, terminated, 10 GHz

5.2.2 RF Switch Module R&S OSP-B102/-B112/-B128

The module R&S OSP-B102 and similar as listed above consists of two SP6T switches. Both switches can be programmed independently from each other.

The relay is a failsafe type; i.e. no RF connection is provided from the terminal C (Common) to one of the six terminals when no voltage is applied to the relay. To

maintain an RF connection between the terminal C (Common) and one of the six output terminals, a continuous voltage is to be applied to the corresponding power terminal of the relay.

Note that always one out of the six terminals of the relays is allowed to be activated at the same time. When operating the R&S OSP-B102 inside the R&S OSP, the R&S OSP firmware takes care for correctly switching the SP6T relay.

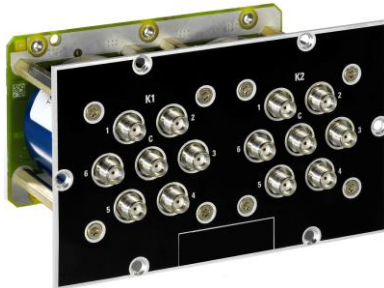

Figure 5-14: Module R&S OSP-B102

The relays are mounted directly in the R&S OSP-B102 front panel. All the RF connectors are SMA female types. All relays are soldered into a printed circuit board; this way the module is of compact size and no cabling to the relays is required.

The R&S OSP-B102 module is supplied and controlled from the R&S OSP via a single connector on the R&S OSP-B102 printed circuit board. The connection to the R&S OSP is done via a single connection cable.

The R&S OSP-B102 module is equipped with an on-board memory to store the necessary configuration data of the module.

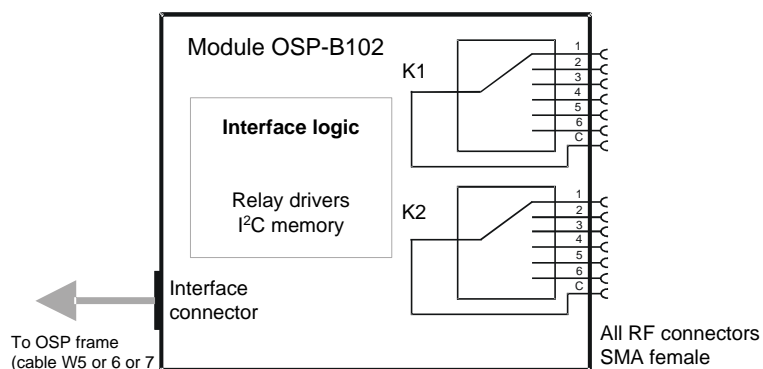

Figure 5-15: Block Diagram Module R&S OSP-B102

When the module R&S OSP-B102 is configured within the R&S OSP, a manual operation of the module can be performed via the OSP Panel. See chapter 3.3.7 for details.

For remote control operation see chapters 6 and 7 in the operating manual.

Depending on the required switching application, several modules of the R&S OSP-B102 type can be installed in one R&S OSP.

In the R&S OSP frame a maximum of three modules is possible. If more than three modules are required, the extension unit R&S OSP150 must be used. For further

information on the extension unit R&S OSP150 see chapter 8.2 in the operating manual.

The description above applies to further options of the R&S OSP as far as the option has got a similar relay configuration. It will apply to the following modules:

Option	Relay configuration
R&S OSP-B112	2 x SP6T relay, 40 GHz
R&S OSP-B128	Up to 3 x SP6T relay, solid state, terminated, 10 GHz

The module R&S OSP-B128 can be configured with up to three SP6T relays. The relay configuration is with all SMA connectors in-line (flat relay design). See the following picture.



Figure 5-16: Module R&S OSP-B128

The actual number of SP6T relays fitted in the R&S OSP-B128 can be read from the module via I²C interface. The R&S OSP automatically recognizes the actual configuration.

Please note that the relays always must be configured starting from position K1 onwards. In the above picture two relays are fitted; the openings for K3 are covered by a sheet metal strip.

5.2.3 I/O Module R&S OSP-B103

The module R&S OSP-B103 is a digital I/O module consisting of a 16 bit input and a 16 bit output port.

The input ports are available on the upper D-Sub connector. The input port can be read at any time. Each input is protected with low-pass and diode against transients.

The output ports are accessible on the lower D-Sub connector. Each output channel is designed as a FET driver switching to GND when activated. Each output is protected with diode against transients which may occur when switching inductive loads such as relay coils.

All output lines can be programmed independently from each other.



Figure 5-17: Module R&S OSP-B103

The R&S OSP-B103 module is supplied and controlled from the R&S OSP via a single connector on the R&S OSP-B103 printed circuit board. The connection to the R&S OSP is done via a single connection cable.

The R&S OSP-B103 module is equipped with an on-board memory to store the necessary configuration data of the module.

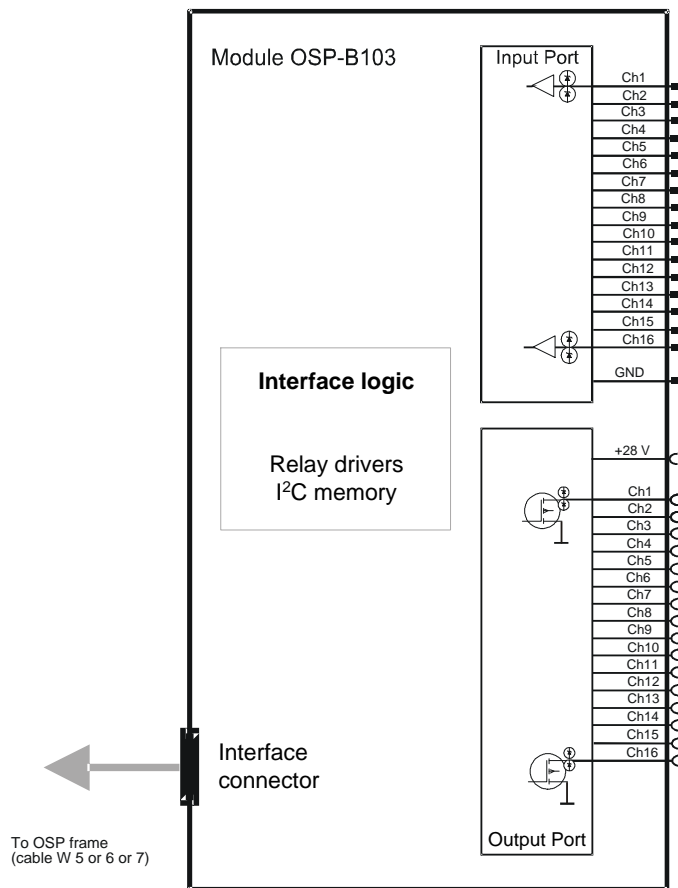

Figure 5-18: Block Diagram Module R&S OSP-B103

When the module R&S OSP-B103 is configured within the R&S OSP, a manual operation of the module can be performed via the OSP Panel. See chapter 3.3.9 for details. For remote control operation see chapters 6 and 7 in the operating manual.

See chapter 9.2.3 in the operating manual for details on the connector pin assignments.

Depending on the required application, several modules of the R&S OSP-B103 type can be installed in one R&S OSP.

In the R&S OSP frame a maximum of three modules is possible. If more than three modules are required, the extension unit R&S OSP150 must be used. For further information on the extension unit R&S OSP150 see chapter 8.2 in the operating manual.

5.2.4 I/O Module R&S OSP-B104

The module R&S OSP-B104 is a digital I/O module for special applications in EMS measurements.



Figure 5-19: Module R&S OSP-B104

It consists of input / output ports allowing control of up to four external power transfer relays, models Spinner BN 51 26 70 (7-16 connectors) or BN 64 00 75 (EIA 1 5/8" flange connectors). In addition, some lines of the ports are made available at an IN / OUT connector.

Transfer switch



The transfer relays are switched by control lines exhibiting a pulse rather than a constant level. For that reason two lines are required to set the switch to each position. Note that the state of the switch does not change state when the R&S OSP is turned on (reset condition).

The Spinner transfer relays support the “carrier safety contact” concept. While turning from one position to the other, this contact opens. If included in the interlock, the power amplifier connected to the interlock control will be deactivated while the relay is turning. In the final position the carrier safety contact closes again, thus closing the full interlock chain. The power amplifier then can also be put into operate mode again.

The relays have a contact indicating the position. This line is read from the module and used to display and verify the current status.

Delay time for Transfer switch



The transfer relays may have a settling time which cannot be neglected. Per default a delay time of 100 msec is set up for the R&S OSP-B104 module. The delay time allows the relay to reach it's final position before the new position is read back. Refer to chapter 7.4.3 in the operating manual for further information on how to change the delay time for the R&S OSP-B104 relays.

In the lower part of the module, on the outside of the lower RELAY connectors, there are four LEDs labeled PWR 1 to PWR 4. If an LED shows a green light, the power is OK. If the LED is off, there is a problem with the power on the corresponding connector. In such a case, please turn off the R&S OSP, try to correct for a possible fault in the cabling or connected relay, turn the R&S OSP back on and check the LED again.

In the middle between the lower RELAY connectors there are two more LEDs. The upper of the two is labeled PWR I/O and gives a status information on the power for the I/O connector. If the LED shows a green light, the power is OK. If the LED is off, there is a problem with the power on the corresponding connector. In such a case, please turn off the R&S OSP, try to correct for a possible fault in the cabling or the connected device, turn the R&S OSP back on and check the LED again.

The LED below indicates the status of the interlock (pins 7 and 15). If there is no connection between these two pins, or if any of the RELAY connectors does not connect its pins 3 and 4 (bridge at the connector or carrier safety status of the connected relay), the LED will show a red light indicating an open interlock. The LED being off indicates that the interlock is closed.

The input ports are available on the upper D-Sub connector IN / OUT. The input port can be read at any time. Each input is protected with low-pass and diode against transients.

The output ports are also accessible on the upper D-Sub connector IN / OUT. Each output channel is designed as a FET driver switching to GND when activated. Each output is protected with diode against transients which may occur when switching inductive loads such as relay coils. All output lines can be programmed independently from each other.

The R&S OSP-B104 module is supplied and controlled from the R&S OSP via one supply and one control connector on the R&S OSP-B104 printed circuit board. The connection to the R&S OSP is done via those two connection cables.

The R&S OSP-B104 module is equipped with an on-board memory to store the necessary configuration data of the module.

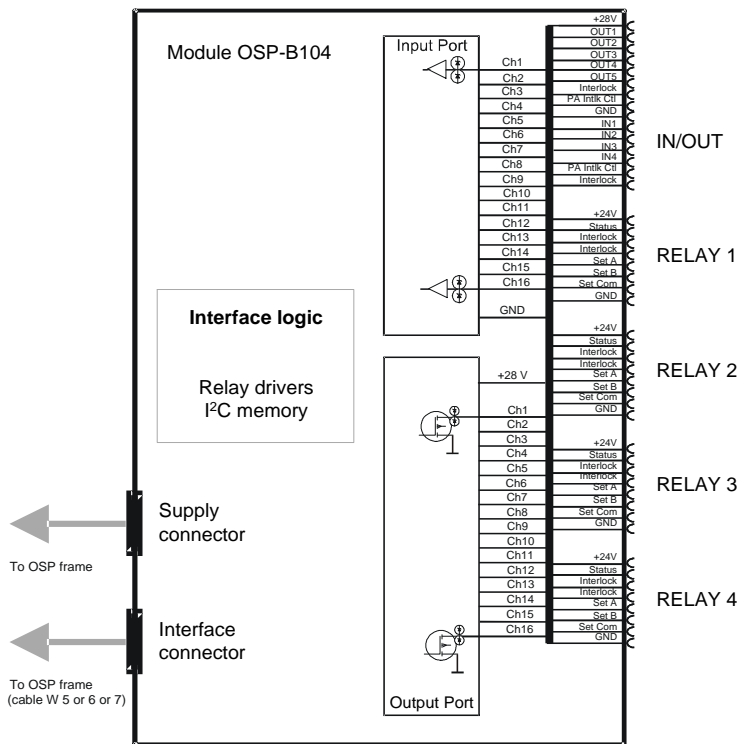

Figure 5-20: Block Diagram Module R&S OSP-B104

When the module R&S OSP-B104 is configured within the R&S OSP, a manual operation of the module can be performed via the OSP Panel. See chapter 3.3.9 for details.

For remote control operation see chapters 6 and 7 in the operating manual. See chapter 9.2.4 in the operating manual for details on the connector pin assignments.

Depending on the required application, several modules of the R&S OSP-B104 type can be installed in one R&S OSP.

In the R&S OSP frame a maximum of two modules is possible, due to the size of the module it only can be installed in slots A12 or A13. If more than two modules are required, the extension unit R&S OSP150 must be used. For further information on the extension unit R&S OSP150 see chapter 8.2 in the operating manual.

5.2.5 RF Switch Module R&S OSP-B106/-B132

The module R&S OSP-B106 consists of three SPDT switches with N connectors and three SPDT switches with BNC connectors.

All six switches can be operated independently from each other.

The relays are a failsafe type; i.e. an RF connection is provided from the terminal C (Common) to the position NC (normally closed) with no voltage applied to the relay. To maintain an RF connection between the terminal C (Common) and the position NO (normally open), a continuous voltage is to be applied to the relay.



Figure 5-21: Module R&S OSP-B106

The relays are mounted directly in the R&S OSP-B106 front panel. Three of the relays (K1 to K3) have N type connectors and are suited for frequencies up to 12 GHz. The other three (K4 to K6) have BNC connectors and may be used up to 900 MHz or for DC currents of up to 2 A at a maximum voltage of 30 V. There are no additional RF cables inside the module.

The R&S OSP-B106 module is supplied and controlled from the R&S OSP via a single connector on the R&S OSP-B106 printed circuit board. The connection to the R&S OSP is done via a single connection cable.

The R&S OSP-B106 module is equipped with an on-board memory to store the necessary configuration data of the module.

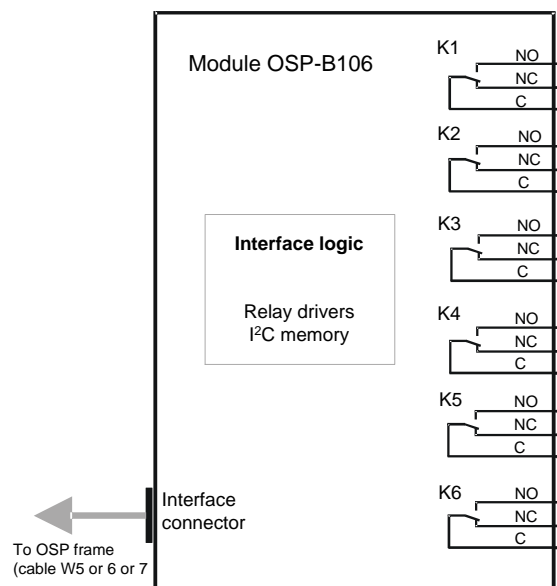

Figure 5-22: Block Diagram Module R&S OSP-B106

When the module R&S OSP-B106 is configured within the R&S OSP, a manual operation of the module can be performed via the OSP Panel. See chapter 3.3.6 for details.

For remote control operation see chapters 6 and 7 in the operating manual. See chapter 9.2.6 in the operating manual for details on the connector pin assignments.

The module R&S OSP-B106 has a double width. Therefore only one module can be installed in one R&S OSP frame. If more than one module is required, the extension unit R&S OSP150 must be used. For further information on the extension unit R&S OSP150 see chapter 8.2 in the operating manual.

The description above applies to further options of the R&S OSP as far as the option has got a similar relay configuration. It will apply to the following modules:

Option	Relay configuration
R&S OSP-B132	6 x SPDT relay with N-Connectors, 12 GHz

5.2.6 DC MUX Module R&S OSP-B108

The module R&S OSP-B108 is a four pole one to six multiplexer for DC. It is controlled equivalent to first Relay K11 of R&S OSP-B102.

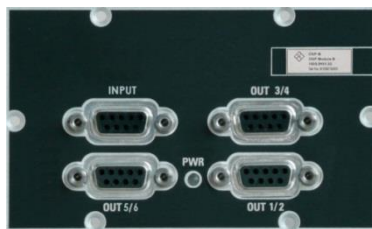

Figure 5-23: Module R&S OSP-B108

The R&S OSP-B108 module is supplied and controlled from the R&S OSP via a single connector on the R&S OSP-B108 printed circuit board.

5.2.7 RF Switch Module R&S OSP-B121 and R&S OSP-B121H

The module R&S OSP-B121 is designed as a universal switching module using terminated RF relays. The R&S OSP-B121 contains the following relay configuration:

3 x SPDT switches (terminated)

The module is designed for independent control of all relay.

The relay is a failsafe type; i.e. a RF connection is provided from the terminal C (Common) to the position NC (normally closed) with no voltage applied to the relay. To maintain a RF connection between the terminal C (Common) and the position NO (normally open), a continuous voltage is to be applied to the relay.



Figure 5-24: Module R&S OSP-B121

The relays are mounted directly in the R&S OSP-B121 front panel. All the RF connectors are SMA female types. All relays are connected via a short cable to a printed circuit board; this way the module is of compact size.

The R&S OSP-B121 module is supplied and controlled from the R&S OSP120 via a single connector on the R&S OSP-B121 printed circuit board. The connection to the OSP120 is done via a single connection cable.

The R&S OSP-B121 module is equipped with a on board memory to store the necessary configuration data of the module.

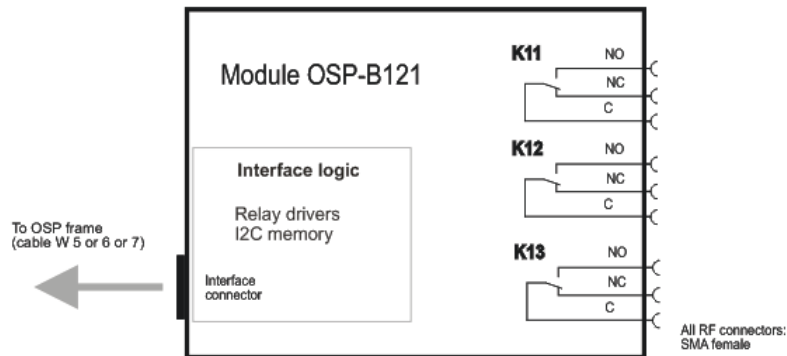

Figure 5-25: Block diagram Module R&S OSP-B121

When the module R&S OSP-B121 is configured within the R&S OSP120, a manual operation of the module can be performed via the OSP Panel. See chapter 3.3 for details.

For Remote Control operation see chapter 6 and 7 in the operating manual.

Depending on the required switching application, several modules of the R&S OSP-B121 type can be installed in one R&S OSP120.

In the R&S OSP frame a maximum of three modules is possible. If more than three modules are required, the extension unit R&S OSP150 must be used. For further information on the extension unit R&S OSP150 see chapter 8.2 in the operating manual.

The description above applies to further options of the R&S OSP as far as the option has got a similar relay configuration. It will apply to the following modules:

Option	Relay configuration
R&S OSP-B121H	3 x SPDT relay with SMA 2.9 Connectors, 40 GHz, terminated

5.2.8 RF Switch Module R&S OSP-B122

The module R&S OSP-B122 is designed as a universal switching module using terminated RF relays. The R&S OSP-B122 contains the following relay configuration:

1 x SP6T switch (terminated)

The relay is a failsafe type; i.e. no RF connection is provided from the terminal C (Common) to one of the six terminals when no voltage is applied to the relay. To maintain a RF connection between the terminal C (Common) and one of the six output

terminals, a continuous voltage is to be applied to the corresponding power terminal of the relay.

Note that always one out of the six terminals of the relays is allowed to be activated at the same time. When operating the R&S OSP-B122 inside the R&S OSP, the R&S OSP firmware takes care for correct switching of the SD6T relay.



Figure 5-26: Module R&S OSP-B122

The relay is mounted directly in the R&S OSP-B122 front panel. All the RF connectors are SMA female types. The relay is connected via a short cable to a printed circuit board; this way the module is of compact size.

The R&S OSP-B122 module is supplied and controlled from the R&S OSP120 via a single connector on the R&S OSP-B122 printed circuit board. The connection to the R&S OSP120 is done via a single connection cable.

The R&S OSP-B122 module is equipped with a on board memory to store the necessary configuration data of the module.

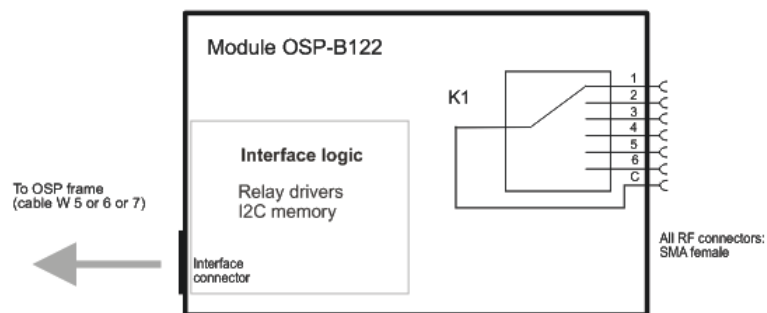

Figure 5-27: Block diagram Module R&S OSP-B122

When the module R&S OSP-B122 is configured within the R&S OSP120, a manual operation of the module can be performed via the OSP Panel. See chapter 3.3 for details.

For Remote Control operation see chapter 6 and 7 in the operating manual.

Depending on the required switching application, several modules of the R&S OSP-B122 type can be installed in one R&S OSP120.

In the R&S OSP frame a maximum of three modules is possible. If more than three modules are required, the extension unit R&S OSP150 must be used. For further information on the extension unit R&S OSP150 see chapter 8.2.

5.2.9 RF Switch Module R&S OSP-B123 and R&S OSP-B124

The module R&S OSP-B123/124 is designed as a universal switching module using terminated RF relays. The R&S OSP-B123/124 contains the following relay configuration:

R&S OSP-B123

6 x SPDT switches (terminated)

1 x SP6T switch (terminated)

R&S OSP-B124

3 x SPDT switches (terminated)

2 x SP6T switch (terminated)

The module is designed for independent control of all relay.

The relay is a failsafe type. In case of the SP6T relay, no RF connection is provided from the terminal C (Common) to one of the six terminals when no voltage is applied to the relay. To maintain a RF connection between the terminal C (Common) and one of the six output terminals, a continuous voltage is to be applied to the corresponding power terminal of the relay.

In case of the SPDT relay, a RF connection is provided from the terminal C (Common) to the position NC (normally closed) with no voltage applied to the relay. To maintain a RF connection between the terminal C (Common) and the position NO (normally open), a continuous voltage is to be applied to the relay.

Note that for the SP6T relay only one out of the six terminals is allowed to be activated at the same time. When operating the R&S OSP-B123/124 inside the R&S OSP, the R&S OSP firmware takes care for correct switching of the SD6T relay.



Figure 5-28: Module R&S OSP-B123



Figure 5-29: Module R&S OSP-B124

All relays are is mounted directly in the R&S OSP-B123/124 front panel. All the RF connectors are SMA female types. All relays are connected via a short cable to a printed circuit board; this way the module is of compact size.

The R&S OSP-B123/124 module is supplied and controlled from the OSP120 via a single connector on the R&S OSP-B123/124 printed circuit board (R&S OSP-B123 has got two boards). The connection to the R&S OSP120 is done via one (R&S OSP-B123) or two (R&S OSP-B124) connection cables.

The R&S OSP-B123/124 module is equipped with a on board memory to store the necessary configuration data of the module.

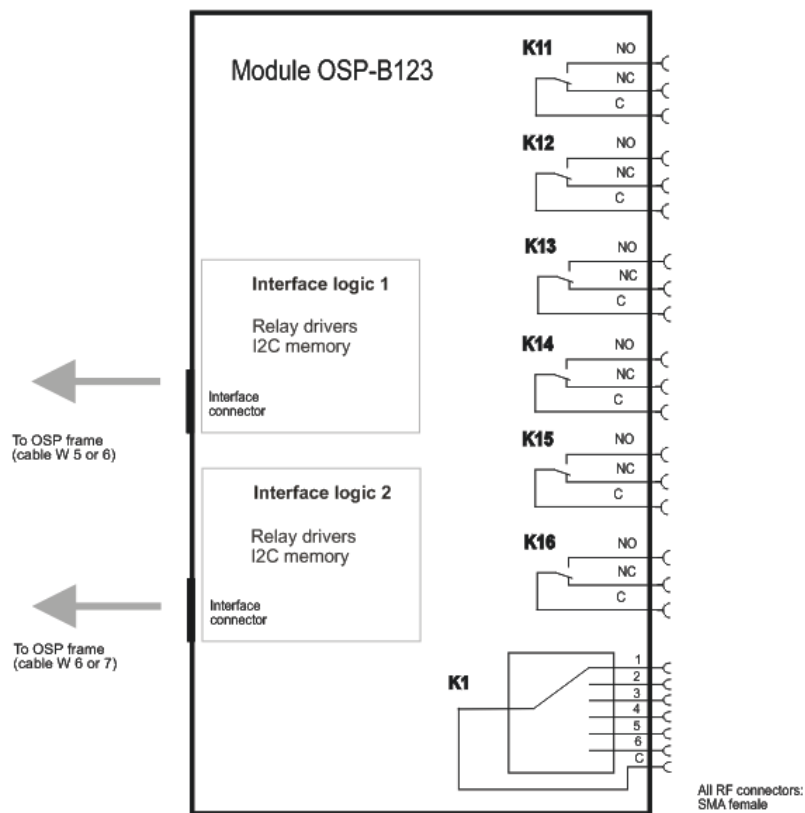

Figure 5-30: Block diagram Module R&S OSP-B123

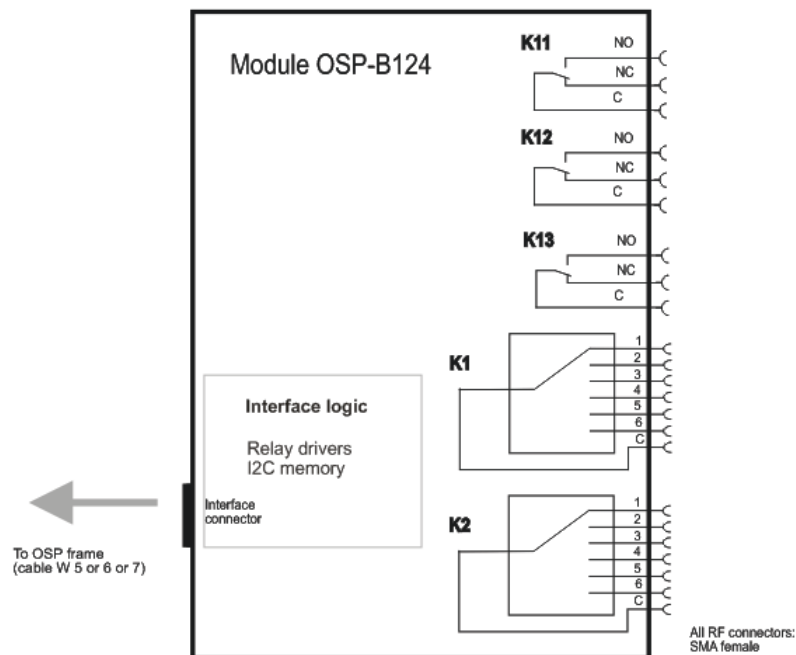

Figure 5-31: Block diagram Module R&S OSP-B124

When the module R&S OSP-B123/124 is configured within the R&S OSP120, a manual operation of the module can be performed via the OSP Panel. See chapter 3.3 for details.

For Remote Control operation see chapter 6 and 7 in the operating manual.

The R&S OSP-B123/124 is a two-slot module. Within one R&S OSP120, only one module of this type can be installed.

The R&S OSP frame offers a maximum of three slots. If more than one R&S OSP-B123/124 are required, the extension unit R&S OSP150 must be used. For further information on the extension unit R&S OSP150 see chapter 8.2 in the operating manual.

5.2.10 RF Switch Module R&S OSP-B125 and R&S OSP-B126

The module R&S OSP-B125/126 is designed as a universal switching module using terminated RF relays. The R&S OSP-B125/126 contains the following relay configuration:

R&S OSP-B125

6 x SPDT switches (terminated)

3 x SP6T switch (terminated)

R&S OSP-B126

3 x SP6T switch (terminated)

The module is designed for independent control of all relay.

The relay is a failsafe type. In case of the SP6T relay, no RF connection is provided from the terminal C (Common) to one of the six terminals when no voltage is applied to the relay. To maintain a RF connection between the terminal C (Common) and one

of the six output terminals, a continuous voltage is to be applied to the corresponding power terminal of the relay.

In case of the SPDT relay, a RF connection is provided from the terminal C (Common) to the position NC (normally closed) with no voltage applied to the relay. To maintain a RF connection between the terminal C (Common) and the position NO (normally open), a continuous voltage is to be applied to the relay.

Note that for the SP6T relay only one out of the six terminals is allowed to be activated at the same time. When operating the R&S OSP-B125/126 inside the R&S OSP, the R&S OSP firmware takes care for correct switching of the SD6T relay.



Figure 5-32: Module R&S OSP-B125



Figure 5-33: Module R&S OSP-B126

All relays are mounted directly in the R&S OSP-B125/126 front panel. All the RF connectors are SMA female types. All relays are connected via a short cable to a printed circuit board; this way the module is of compact size.

The R&S OSP-B125/126 module is supplied and controlled from the R&S OSP120 via two printed circuit boards mounted on the R&S OSP-B125/126. The connection to the R&S OSP120 is done via two connection cables.

The R&S OSP-B125/126 module is equipped with an on-board memory to store the necessary configuration data of the module.

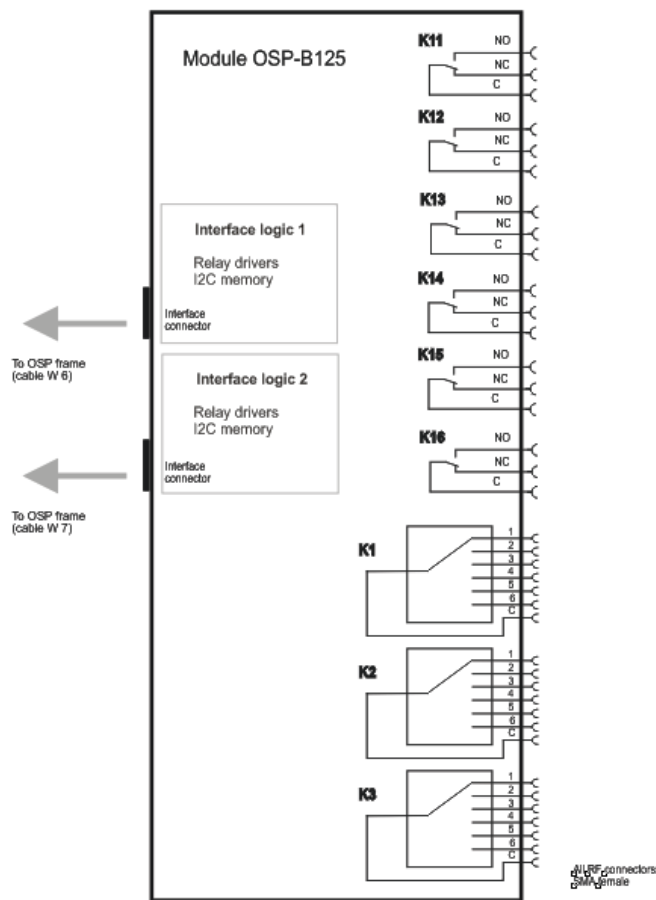

Figure 5-34: Block diagram Module R&S OSP-B125

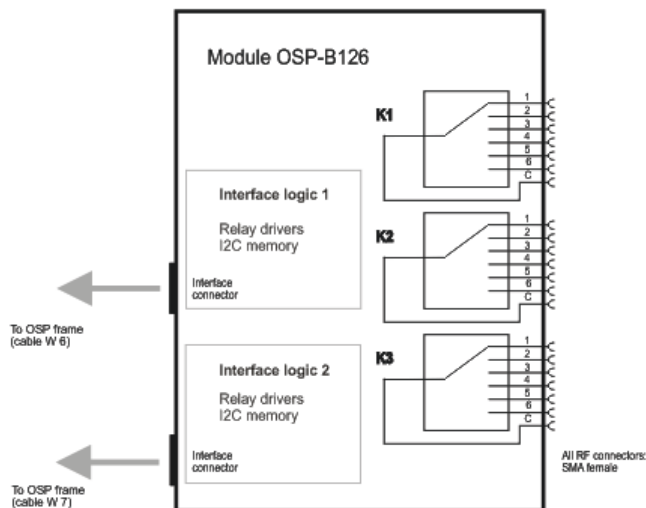

Figure 5-35: Block diagram Module R&S OSP-B126

When the module R&S OSP-B125/126 is configured within the R&S OSP120, a manual operation of the module can be performed via the OSP Panel. See chapter 2.2.5 for details.

For Remote Control operation see chapter 6 and 7 in the operating manual.

The R&S OSP-B125/126 is a three-slot module. Within one R&S OSP120 only one module of this type can be installed.

If more than one R&S OSP-B125/126 are required, the extension unit R&S OSP150 must be used. For further information on the extension unit R&S OSP150 see chapter 8.2 in the operating manual.

5.2.11 Module R&S OSP-B114 for EMS application

The module R&S OSP-B114 is intended for applications in small or medium systems for Electromagnetic Susceptibility (EMS). The module fulfills the following tasks:

- Switching of the output of two power amplifiers to one or two transmit antennas (or other kind of transducers).
- Providing the circuitry for an interlock loop with the following functions:
 - monitoring a interlock loop and read/display the actual status
 - power down external amplifiers depending on interlock status
 - disconnect the signal generator from power amplifier (if they cannot be powered down) depending on interlock status
- Four output lines. Can be used to control the polarization of the transmitting antennas
- Four input lines



Figure 5-36: Module R&S OSP-B114

The relay K1 with N-connectors is a DPDT type. When not activated (no voltage applied to the relay) and after Reset, the terminals 1 - 2 and 3 - 4 are connected. When activated, the terminals 1 - 3 and 2 -4 are connected.

The SPDT relay (K5) with SMA connectors is controlled by the interlock. With interlock loop open, a RF connection is provided from the terminal C (Common) to the position NC (normally closed).

With interlock loop closed, a RF connection is provided between the terminal C (Common) and the position NO (normally open).

The interlock status is shown by the red LED on the module front panel, too.

Red LED switched on → Interlock loop is open
switched off → Interlock loop is closed

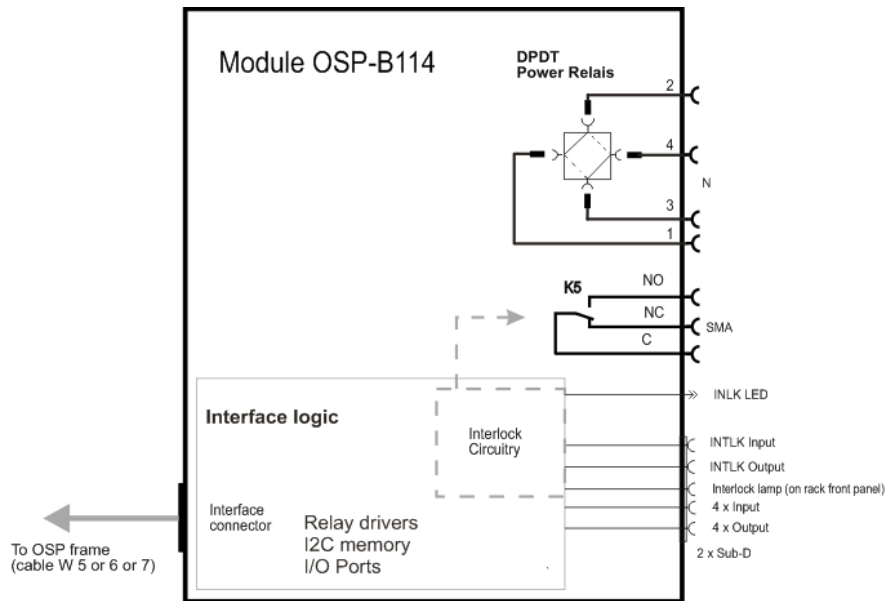

Figure 5-37: Block diagram Module R&S OSP-B114

When the module R&S OSP-B114 is configured within the R&S OSP, a manual operation of the module can be performed via the OSP Panel. See chapter 3.3.9 for details.

For remote control operation see chapters 6 and 7 in the operating manual. For details in the application of this module see chapter 8.6 in the operating manual. See chapter 9.2.4 in the operating manual for details on the connector pin assignments.

5.2.12 RF Switch Module R&S OSP-B131

The module R&S OSP-B131 is designed for high power RF switching. The R&S OSP-B131 contains the following relay configuration:

- 2 x SPDT switches with N-connectors

The module is designed for independent control of both relays.

The relay is a failsafe type; i.e. a RF connection is provided from the terminal C (Common) to the position NC (normally closed) with no voltage applied to the relay. To maintain a RF connection between the terminal C (Common) and the position NO (normally open), a continuous voltage is to be applied to the relay.



Figure 5-38: Module R&S OSP-B131

The relays are mounted directly in the R&S OSP-B131 front panel. All the RF connectors are N female types. All relays are connected via a short cable to a printed circuit board; this way the module is of compact size.

The R&S OSP-B131 module is supplied and controlled from the OSP120 via a single interface connector on the OSP-B131 printed circuit board. The connection to the R&S OSP120 is done via a single connection cable.

The R&S OSP-B131 module is equipped with a on board memory to store the necessary configuration data of the module.

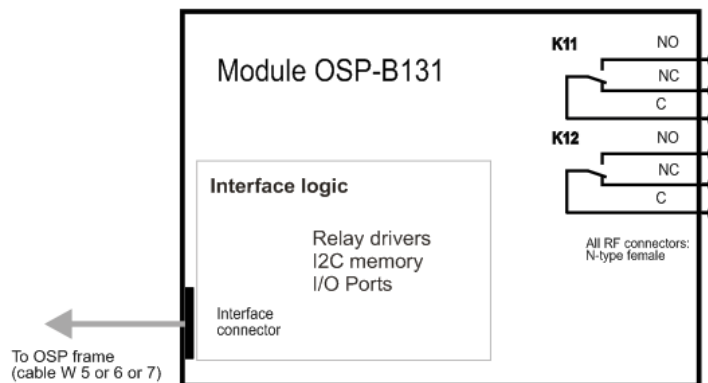

Figure 5-39: Block diagram Module R&S OSP-B131

When the module R&S OSP-B131 is configured within the R&S OSP120, a manual operation of the module can be performed via the OSP Panel. See chapter 2.2.5 for details.

For Remote Control operation see chapter 6 and 7 in the operating manual.

Depending on the required switching application, several modules of the R&S OSP-B131 type can be installed in one R&S OSP120.

In the R&S OSP frame a maximum of three modules is possible. If more than three modules are required, the extension unit R&S OSP150 must be used. For further information on the extension unit R&S OSP150 see chapter 8.2 in the operating manual.

5.2.13 RF Switch Module R&S OSP-B129 and R&S OSP-B119

The module R&S OSP-B129 is designed as a universal switching module using one terminated SP8T relay and two SPDT relays.

The module is designed for independent control of all relay.

The relay is a failsafe type. In case of the SP8T relay, no RF connection is provided from the terminal C (Common) to one of the six terminals when no voltage is applied to the relay. To maintain a RF connection between the terminal C (Common) and one of the six output terminals, a continuous voltage is to be applied to the corresponding power terminal of the relay.

In case of the SPDT relay, a RF connection is provided from the terminal C (Common) to the position NC (normally closed) with no voltage applied to the relay. To maintain a

RF connection between the terminal C (Common) and the position NO (normally open), a continuous voltage is to be applied to the relay.

Note that for the SP8T relay only one out of the eight terminals is allowed to be activated at the same time. When operating the R&S OSP-B129 inside the R&S OSP, the R&S OSP firmware takes care for correct switching of the SD8T relay.



Figure 5-40: Module R&S OSP-B129 and R&S OSP-B119

All relays are mounted directly in the OSP-B129 front panel. All the RF connectors are SMA female types. All relays are connected via a short cable to a printed circuit board; this way the module is of compact size.

The OSP-B129 module is supplied and controlled from the OSP120 via a single connector on the OSP-B129 printed circuit board. The connection to the OSP120 is done via one connection cable.

The OSP-B129 module is equipped with a on board memory to store the necessary configuration data of the module.

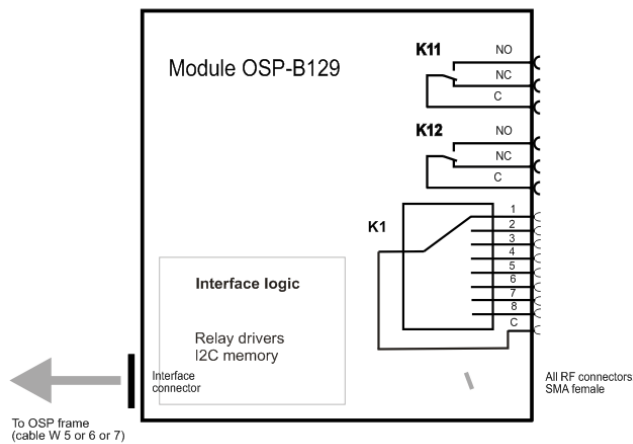

Figure 5-41: Block diagram Module R&S OSP-B129

When the module R&S OSP-B129 is configured within the R&S OSP120, a manual operation of the module can be performed via the OSP Panel. See chapter 3.3 for details.

For Remote Control operation see chapter 6 and 7 in the operating manual.

The R&S OSP-B129 is a one-slot module. Within one R&S OSP120 up to three modules of this type can be installed.

The R&S OSP frame offers a maximum of three slots. If more than one R&S OSP-

B129 are required, the extension unit R&S OSP150 must be used. For further information on the extension unit R&S OSP150 see chapter 8.2 in the operating manual.

The description above applies to further options of the R&S OSP as far as the option has got a similar relay configuration. It will apply to the following modules:

Option	Relay configuration
R&S OSP-B119	1 x SP8T relay, non terminated 2 x SPDT relay, non terminated

5.2.14 Power Sensor Module R&S OSP-PM-I

The module R&S OSP-PM-I allows to integrate a Power Sensor within the R&S OSP. The module R&S OSP-PM-I includes one N-type feed-through connector and one USB Adapter, both mounted in the modules front panel.

The module needs to be completed with a Power Sensor of the R&S family NRP-Zxx. It is recommended to use a power sensor version with short cable (for example R&S NRP-Z211 with Id. No. 1417.0409.04).

The module R&S OSP-PM-I is designed with base plate, where the Power Sensor together with cable is fitted. The Power Sensor with its N-type connector is directly screwed to the modules N-type feed-through connector. The Power Sensor is controlled via USB interface. The Power Sensors USB connector (Odumac L-series with 6 pins) is connected to the USB Adapter. The USB adapter serves as filter at the same time.



Figure 5-42: Module R&S OSP-PM-I

The module R&S OSP-PM-I just is used as housing for the Power Sensor. There is no connection to R&S OSP internal interface. See following block diagram.

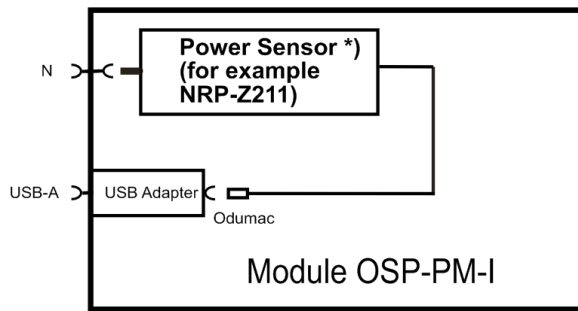

*) Power Sensor is not part of the module OSP-PM-I

Figure 5-43: Block diagram Module R&S OSP-PM-I

The R&S OSP-PM-I is a one-slot module. Within one R&S OSP120 up to three modules of this type can be installed.

5.2.15 RF Switch Module R&S OSP-B116 and R&S OSP-B136

The module R&S OSP-B116 and -B136 are designed as a universal switching modules using two transfer switches DPDT.

The modules are designed for independent control of both relays.

The module R&S OSP-B116 is configured with two transfer relays and SMA connector type, the R&S OSP-B136 with two transfer relays and N connector type.

When not activated (no voltage applied to the relay) and after Reset, the terminals 1 - 2 and 3 - 4 are connected.

When activated, the terminals 1 - 3 and 2 - 4 are connected.

Both the modules R&S OSP-B116/-136 module is equipped with a on board memory to store the necessary configuration data of the module.configuration data of the module.

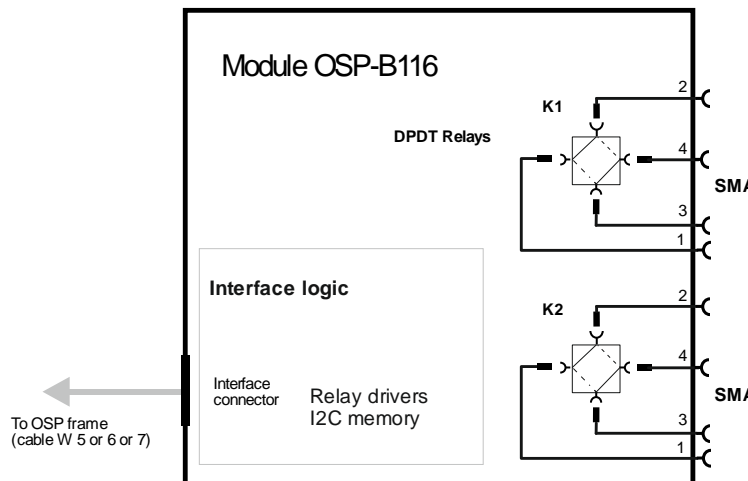

Figure 5-44: Block diagram Module R&S OSP-B116

The module R&S OSP-B136 is equipped with N-connector relays. See following pictures.

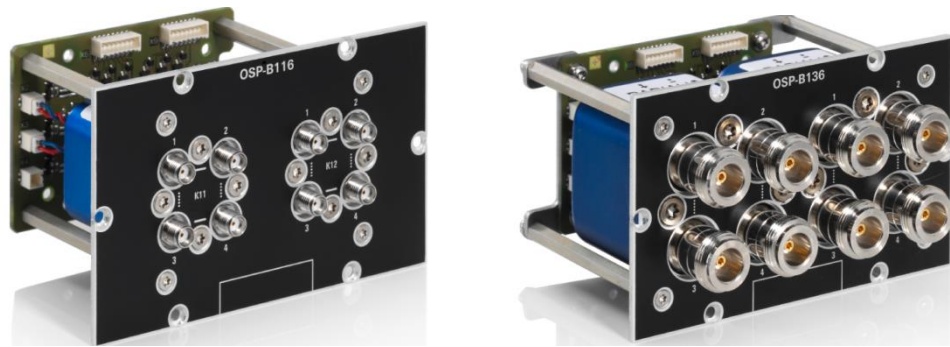

Figure 5-45: Module R&S OSP-B116 and R&S OSP-B136

When the module R&S OSP-B116/-136 is configured within the R&S OSP, a manual operation of the module can be performed via the OSP Panel. See chapter 3.3.9 for details.

For remote control operation see chapters 6 and 7 in the operating manual.
For details in the application of this module see chapter 8.6 in the operating manual
See chapter 9.2.4 in the operating manual for details on the connector pin assignments.

The R&S OSP-B116/-136 is a one-slot module. Within one R&S OSP base unit up to three modules of this type can be installed.

5.2.16 RF Switch Module R&S OSP-B101L and R&S OSP-B102L

The modules R&S OSP-B101L and R&S OSP-B102L are designed as a universal RF switch modules using latched relay types.

The latching relay type will maintain a chosen RF connection whether voltage is maintained or not after switching is accomplished. The relay switching is done by applying a voltage pulse to the relay; after that no energy is consumed by this relay type.



Figure 5-46: Module R&S OSP-B101L and R&S OSP-B102L

The relays are mounted directly in the module front panel. All the RF connectors are SMA female types. All relays are connected via a short cable to a printed circuit board; this way the module is of compact size.

Both modules are supplied and controlled from the R&S OSP base unit via a single interface connector on the modules printed circuit board; the connection is just via a single connection cable.

Both the R&S OSP-B101L and R&S OSP-B102L module is equipped with an on board memory to store the necessary configuration data of the module.

Port designation:

In comparison to the module R&S OSP-B101 with monostable relays, the R&S OSP-B101L relays ports are labelled with 1 and 2 since after power off the last relay condition is maintained.

Latched type relays and Reset Condition:

As already mentioned above, the last relay condition is maintained after power off. The R&S OSP firmware foresees two possibilities when powering on the R&S OSP. See following overview:

Power On Mode	Effect	Controlled via SCPI
Reset latched type relays	SPDT relay set to position 2 SP6T relay set to open position	CONFIGURE:POWERUP:RESET "ON"
Keep latched type relay condition	Keep last state	CONFIGURE:POWERUP:RESET "OFF"

⚠ CAUTION

Power On condition of module R&S OSP-B101L and R&S OSP-B102L

It is in the responsibility of the user to define the Power Up condition of both the modules. Please note the instructions given above!

Per default the Power On condition for the latched relays is set to `POWERUP:RESET "ON"`. The current setting can be read via SCPI command `CONFIGURE:POWERUP:RESET?`. See chapter 7.4.3 in the operating manual for further information on the `CONFIGURE` commands.

5.2.17 I/O and supply Module R&S OSP-B158

The module R&S OSP-B158 is designed as a power supply and control module. It consists of a 16 bit input, a 16 bit differential RS422 output and a power supply connector. All ports are D-Sub connectors, male for input, female for output and power supply.

On the left side of the module, there are four LEDs, labeled +12 V, -12 V, +10 V and +28 V. If all LEDs show a green light, the power is OK. If one LED is off, there is a problem with the power supply of the corresponding voltage and probably the maximum current is exceeded (see data sheet). In such a case, please turn off the R&S OSP, disconnect any cable connected to the supply connector and turn the R&S OSP back on and check the LED again.

The LED labeled EXT shows a green light, if a 3.3 V voltage is supplied at the input connector pin 17 (AUX-IN), see chapter 3.3.8

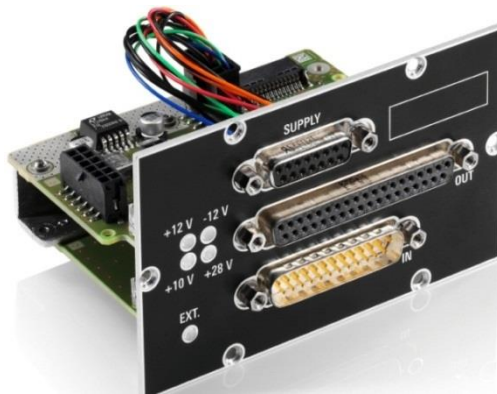

Figure 5-47: Module R&S OSP-B158

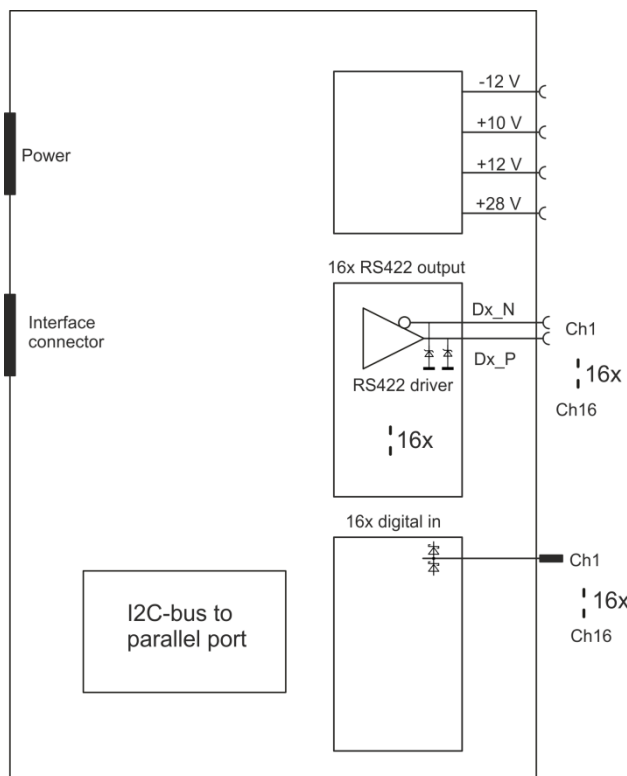

Figure 5-48: Block Diagram Module R&S OSP-B158

When the module R&S OSP-B158 is configured within the R&S OSP, a manual operation of the module can be performed via the OSP Panel. See chapter 3.3.8 for details. For remote control operation see chapters 6 and 7 in the operating manual.

See chapter 9.2.21 in the operating manual for details on the connector pin assignments.

5.2.18 RF Switch Module R&S OSP-B142

The module R&S OSP-B142 is designed as a universal RF switch modules using solid state relay types. Depending on the variant it consists of one, two or three SPDT switches or of three DP3T switches. All switches can be operated independently from each other.

The solid state relay allows handling of up to 40 dBm in a frequency range up to 8 GHz.

The relay is a solid state type; i.e. an RF connection is provided from the terminal C (Common) to the position P2 only with power switched on. When the relay is activated, the terminal C is connected to position P1.



Figure 5-49: Module R&S OSP-B142 (variant .03 with 3 DP3T switches)

The relays are mounted directly in the module front panel. All the RF connectors are SMA female types. All relays are plugged into a kind of backplane; this way the module is of compact size and no cabling to the relays is required.

The R&S OSP-B142 module is supplied with power and controlled from the R&S OSP base unit via a single interface connector on the module's printed circuit board; the connection is done via a single connection cable.

The R&S OSP-B142 module is equipped with on-board memory to store the configuration data of the module.

The R&S OSP-B142 exists in four different variants:

Variant	Relay configuration
OSP-B142 V03	3 x DP3T relay, sold state, w/o external termination
OSP-B142 V11	1 x SPDT relay, sold state, with external termination
OSP-B142 V12	2 x SPDT relay, sold state, with external termination
OSP-B142 V13	3 x SPDT relay, sold state, with external termination

5.3 Graphical User Interface

The R&S OSP130 can operate in local mode by means of its integrated operating elements and display screen. This chapter gives details for the operation of the instrument using the graphical user interface (GUI).

The same graphical user interface is available also for the R&S OSP120 when connected to a computer via LAN, and running some browser on this computer.

The following sections can help you to make efficient use of the OSP GUI of the R&S OSP. For additional information on using the OSP Panel see chapter 3.3.

5.3.1 Starting the R&S OSP120

Connect Monitor and mouse / keyboard to the R&S OSP120 instrument. After power-on, the instrument is in ready state after about 30 seconds. The graphical user interface is available when the R&S OSP120 is connected to a computer via LAN, and running some browser (Internet Explorer or Mozilla Firefox for example) on this computer. Type the following as URL:





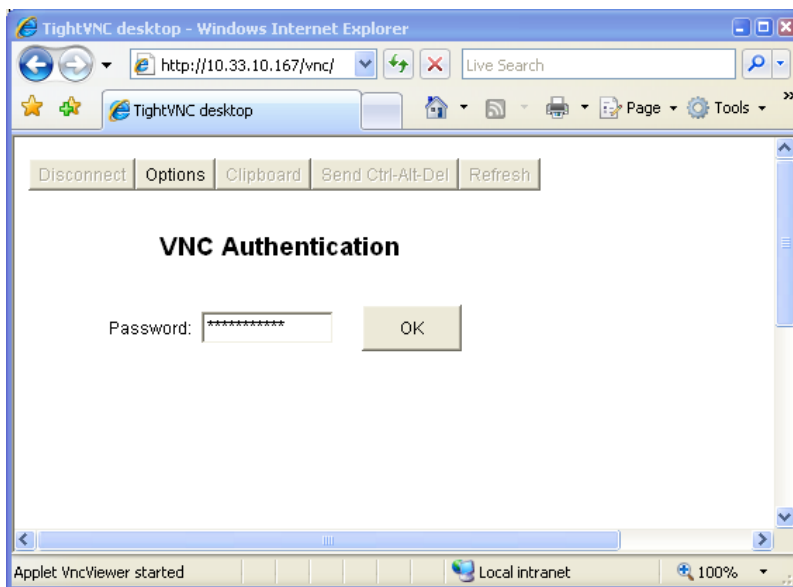

http://192.168.48.147/vnc (example with R&S OSP default IP address, see chapter 2.9 for more information on IP address).

In the following dialog you are prompted for a password. Type **instruments** as password.



When finished the start screen displays some information on the equipment, as described in the following section.

The following keystrokes on the external keyboard correspond to the keys on the front panel of the R&S OSP130:

	key on R&S OSP130 front panel	corresponding keyboard key
	MENU Top level menu	CTRL + M
	BACK up in hierarchy by one menu level	ESC
	HOME Start screen	CTRL + H
	cursor keys	cursor keys or mouse
	FUNCTION switching action, if applicable.	CTRL + F
	OK confirms a selection	Enter, or mouse click
	STATUS status information or changes selection of a switch for path configuration.	CTRL + S

5.3.2 Starting the R&S OSP130

After power-on, the R&S OSP130 instrument is in ready state after about 30 seconds. When finished the start screen displays some information on the equipment:

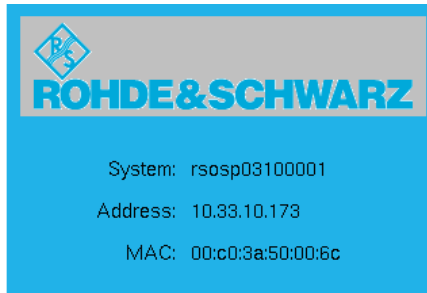

The field System gives the string rsospvvnvvnnnn where vv is the two-digit type (e.g. 03 for R&S OSP130), and nnnnnn the serial number of the instrument.

Address indicates the IP address (see chapter 2.9).

With MAC the instrument's MAC address is shown.

Pressing the key **MENU**, **RESET** or **OK** while the start screen is displayed will then go to the top level menu (Main menu).

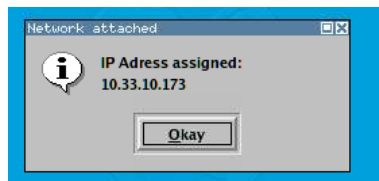

Before that start screen or during one of the following operations there might be some display of the instrument's IP address. You may need to press the **OK** key in order to close this dialog.

5.3.3 General Navigation Operations

The instruction in this section describe how to access the various menu levels, the modules of the instrument, and some general pieces of information.

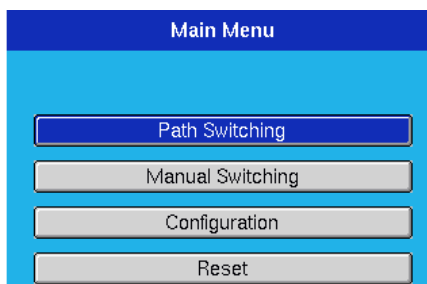

With the cursor keys, the appropriate menu function can be selected.

Selecting Manual Switching and pressing **OK** will display a screen as follows:

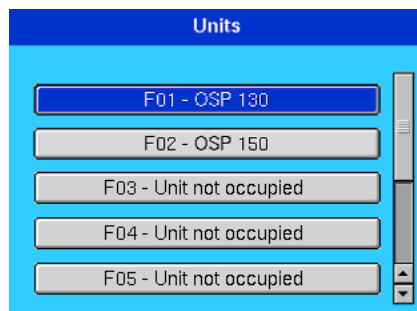

The example here shows an R&S OSP130 connected with a single extension unit R&S OSP150.

If an extension unit R&S OSP150 is located on F02 to F09, it can be selected from this dialog.

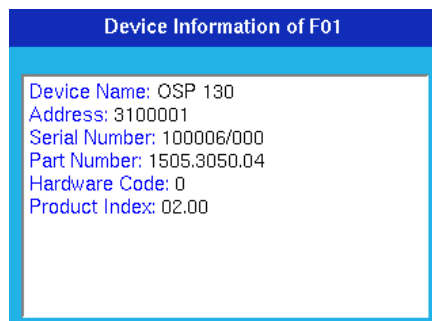

While the selection to one of the units is made, pressing the **STATUS** key will display some information on the unit. See the example.

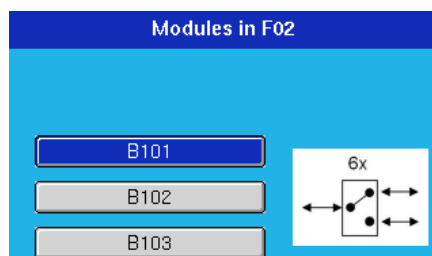

Selecting the unit and pressing **OK** will move into the next dialog.

Depending on the modules fitted to the unit, the available selections will vary. In the example on the left hand side the first slot is equipped with an R&S OSP-B101, the second with an R&S OSP-B102, and the third with an R&S OSP-B103. Next to the selected module some picture visualizes the capability of the module, in the case of the R&S OSP-B101 indicated by a SPDT switch and the count 6x.

Device Information of (F02) A11

Device Name: OSP-B101
 Description: 6 x SPDT
 Serial Number: 100002/002
 Part Number: 1505.5101.02
 Hardware Code: 0
 Product Index: 02.02

While the selection to one of the modules is made, pressing the **STATUS** key will display some information on the module. See the example.
 For completeness, see more examples of module information.

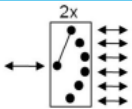
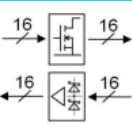
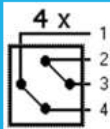
<p>Modules in F02</p> <p>B101</p> <p>B102</p> <p>B103</p> 	<p>Device Information of (F02) A12</p> <p>Device Name: OSP-B102 Description: 2 x SP6T Serial Number: 100004/002 Part Number: 1505.5201.02 Hardware Code: 0 Product Index: 02.02</p>
<p>Modules in F02</p> <p>B101</p> <p>B102</p> <p>B103</p> 	<p>Device Information of (F02) A13</p> <p>Device Name: OSP-B103 Description: 16 x IO Serial Number: 100001/002 Part Number: 1505.5301.02 Hardware Code: 0 Product Index: 02.02</p>
<p>Modules in F01</p> <p>B101</p> <p>B104</p> <p>B102</p> 	<p>Device Information of (F01) A12</p> <p>Device Name: OSP-B104 Description: 4 x SPDT-IO Serial Number: 100008/000 Part Number: 1505.5401.02 Hardware Code: 0 Product Index: 01.00</p>

BACK

From any menu level, this key will bring you one level up in hierarchy.

MENU

From any menu level, this key will bring you directly to the Main menu.

5.3.4 Using the R&S OSP-B101/-B106/-B107/-B111

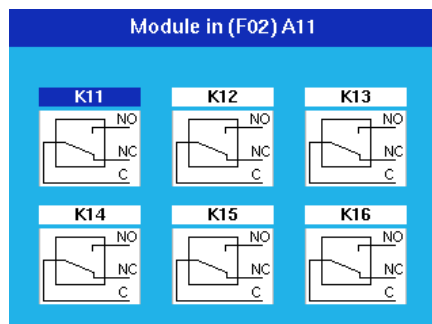

After selection of the R&S OSP-B101 module this dialog is opened.

With the cursor keys one of the six relays can be chosen, indicated by the blue color in the relay name.

Pressing the **FUNCTION** key toggles the relay from NC to NO and vice versa. The display of the switch in the dialog is changed accordingly.

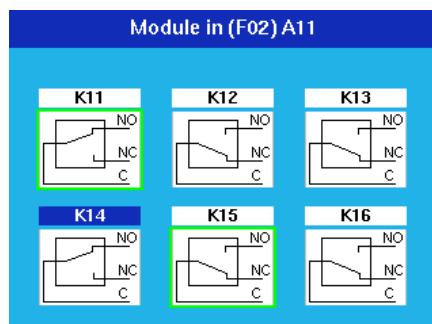

Pressing the key **STATUS** toggles the selection of the relay.

A selected relay (K11 and K15 in this example) is displayed with a green surrounding. All selected relays are taken over into a path configuration.

A non selected relay is not considered when defining a path configuration.

The operation as described above applies to further options of the R&S OSP as far as the option has got a similar relay configuration. It will apply to the following modules:

Option	Relay configuration
R&S OSP-B106	3 x SPDT relay with N connectors, 12 GHz, 3 x SPDT relays with BNC connectors, 900 MHz / 2 A
R&S OSP-B107	6 x SPDT relay, solid state, 6 GHz
R&S OSP-B111	6 x SPDT relay, 40 GHz

Please note that for the module R&S OSP-B106 the relays are numbered from K1 to K6 but from K11 to K16 for all other modules.

5.3.5 Using the R&S OSP-B102/-B112

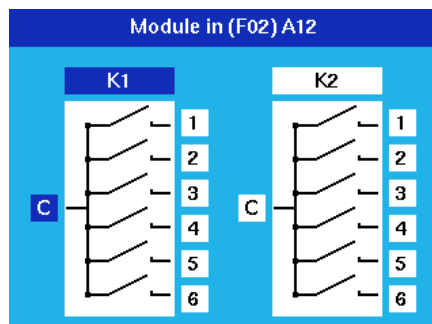

After selection of the R&S OSP-B102 module this dialog is opened.

With the cursor left/right keys you can choose either relay, and with the cursor up/down keys any terminal of that relay, indicated by the blue color. In the example this is terminal 1 of relay K1.

Pressing the **FUNCTION** key closes the chosen relay position. With the Common terminal chosen ("C" displayed in blue) the relay is opened. The display of the switch in the dialog is changed accordingly.

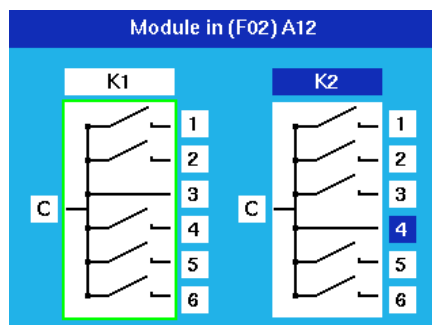

Pressing the key **STATUS** toggles the selection of the relay.

A selected relay (K1 in this example) is displayed with a green surrounding. All selected relays are taken over into a path configuration.

A non selected relay is not considered when defining a path configuration.

The operation as described above applies to further options of the R&S OSP as far as the option has got the same relay configuration. It will apply to the following modules:

Option	Relay configuration
R&S OSP-B112	2 x SP6T relay, 40 GHz
R&S OSP-B108	K1 = K11, DC MUX

5.3.6 Using the R&S OSP-B103

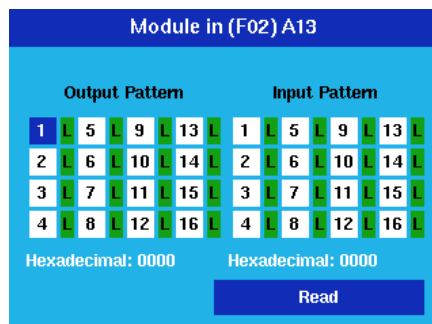

After selection of the R&S OSP-B103 module this dialog is opened.

With the cursor keys any of the 16 output channels can be chosen, indicated by the blue color. In the example this is channel 1.

Pressing the **FUNCTION** key toggles this channel from low (L, dark green) to high (H, red) and vice versa. The display of the channel in the dialog is changed accordingly.

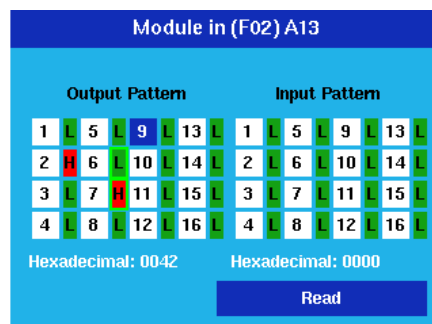

Pressing the key **STATUS** toggles the selection of the channel.

A selected channel (channels 6 and 7 in this example) is displayed with a green surrounding. All selected channels are taken over into a path configuration.

A non selected channel is not considered when defining a path configuration.

In addition to the single channel information a total of all 16 channels is shown as hexadecimal value. Channel 1 corresponds to the lowest bit, having the value 1, whereas channel 16 is the highest bit, having the value 8000.

Pressing the key **OK** will execute a read command reading the status of all input channels. They will be displayed in dark green for low values (L) and in red for high values (H).

In addition to the single channel information a total of all 16 channels is shown as hexadecimal value. Channel 1 corresponds to the lowest bit, having the value 1, whereas channel 16 is the highest bit, having the value 8000.

5.3.7 Using the R&S OSP-B104

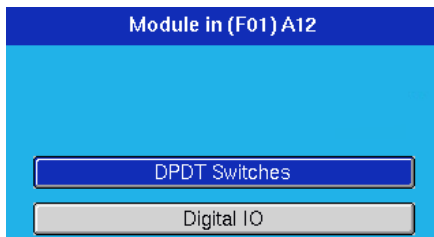

After selection of the R&S OSP-B104 module this dialog is opened. With the cursor key either option can be selected and activated by pressing the key **OK**.

5.3.7.1 Setting the Transfer Relays and Reading the Interlock

In the DPDT Switches case, the following dialog opens.

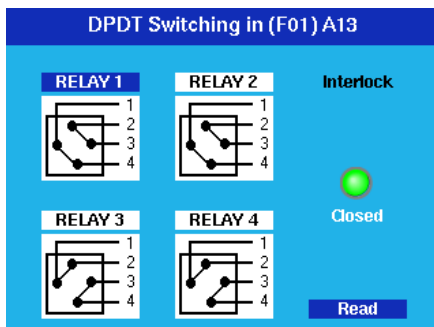

With the cursor keys any of the 4 transfer relays can be chosen, indicated by the blue color. In the example this is RELAY 1.

Pressing the **FUNCTION** key toggles this relay into the opposite position, indicated by the lines between the connectors. In one position the connections are made between connectors 1 and 2 and between 3 and 4. In the other position the connections are made between connectors 1 and 4 and between 2 and 3.

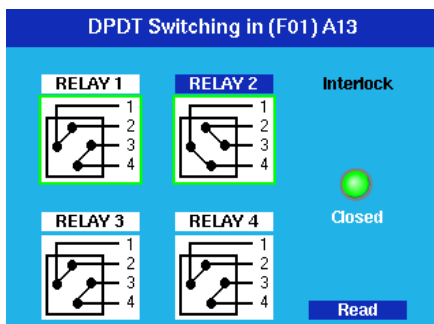

Pressing the key **STATUS** toggles the selection of the relay.

A selected relay (RELAY 1 and RELAY 2 in this example) is displayed with a green surrounding. All selected relays are taken over into a path configuration.

A non selected relay is not considered when defining a path configuration.

Pressing the key **OK** will execute a read command. The status of the interlock, i.e. if there is a connection between pins 7 and 15 of the IN / OUT connector, is indicated. A green signal shows a closed interlock, a red signal an open interlock. If the interlock is closed, a relay also closes a contact between pins 8 and 14 of the IN / OUT connector.

5.3.7.2 Input and Output Pattern

When the Digital I/O had been chosen, the following dialog is shown.

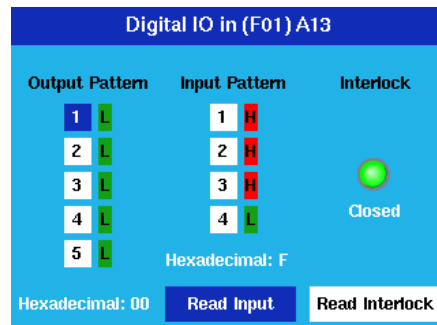

With the cursor up / down keys any of the 5 output channels can be chosen, indicated by the blue color. In the example this is channel 1.

Pressing the **FUNCTION** key toggles this channel from low (L, dark green) to high (H, red) and vice versa. The display of the channel in the dialog is changed accordingly.

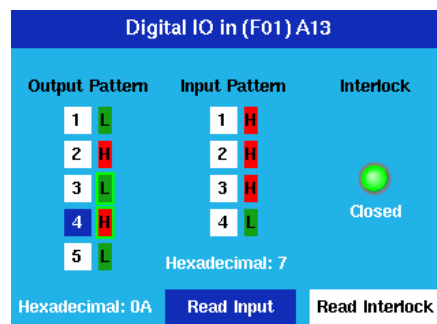

Pressing the key **STATUS** toggles the selection of the channel.

A selected channel (channels 3 and 4 in this example) is displayed with a green surrounding. All selected channels are taken over into a path configuration.

A non selected channel is not considered when defining a path configuration.

With the cursor left / right key either Read Input or Read Interlock can be selected, indicated in blue. Pressing the key **OK** will execute a read command.

In the case of Read Input the status of all input channels is read. They will be displayed in dark green for low values (L) and in red for high values (H). The case of Read Interlock reads the interlock status, see chapter 5.3.7.1.

5.3.8 Using the R&S OSP-B121

After selection of the R&S OSP-B121 module this dialog is opened.

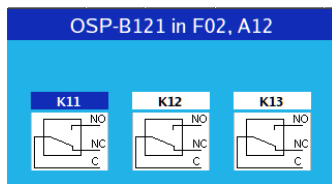

With the cursor keys one of the three relays can be chosen, indicated by the blue color in the relay name.

Pressing the **FUNCTION** key toggles the relay from NC to NO and vice versa. The display of the switch in the dialog is changed accordingly.

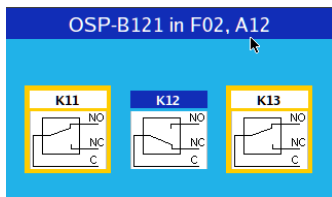

Pressing the key **STATUS** toggles the selection of the relay.

A selected relay (K11 and K13 in this example) is displayed with a green surrounding. All selected relays are taken over into a path configuration. A non selected relay is not considered when defining a path configuration.

5.3.9 Using the R&S OSP-B122

After selection of the R&S OSP-B122 module this dialog is opened.

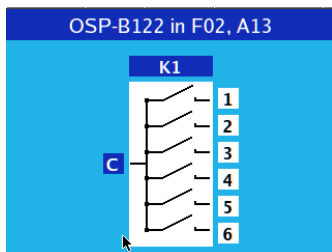

With the cursor up/down keys you can chose any terminal of that relay, indicated by the blue color. In the above example the common terminal C is selected; all six terminals are open.

Pressing the **FUNCTION** key closes the chosen relay position. With the Common terminal chosen ("C" displayed in blue) the relay is opened. The display of the switch in the dialog is changed accordingly.

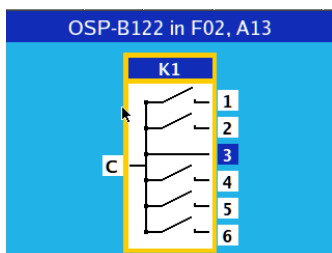

Pressing the key **STATUS** toggles the selection of the relay.

A selected relay (K1 in this example) is displayed with a green surrounding. All selected relays are taken over into a path configuration.

A non selected relay is not considered when defining a path configuration.

5.3.10 Using the R&S OSP-B123 to R&S OSP-B126 and R&S OSP-B129

The modules R&S OSP-B123, R&S OSP-B124, R&S OSP-B125 and R&S OSP-B126 combine different numbers of SPDT and SP6T as they are used in the R&S OSP-B121 and R&S OSP-B122 module, respectively.

The module R&S OSP-B129 houses one terminated SP8T and two SPDT switches.

The following example is given for the module R&S OSP-B125. After selection of the this module the following dialog is opened. This dialog shows all the available relays of the module.

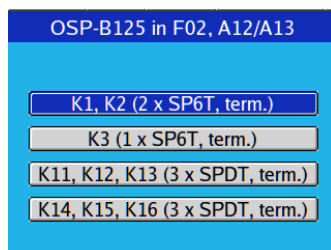

Selecting the first group of relays, a dialog is opened for relay selection and switching.

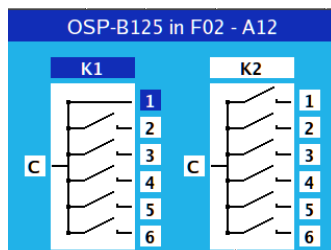

The operation is as usual. With the cursor left/right keys you can chose either relay, and with the cursor up/down keys any terminal of that relay, indicated by the blue color. In the example this is terminal 1 of relay K1.

Pressing the **FUNCTION** key closes the chosen relay position. With the Common terminal chosen ("C" displayed in blue) the relay is opened. The display of the switch in the dialog is changed accordingly.

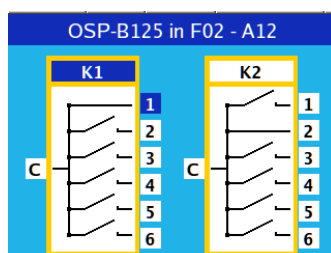

Pressing the key **STATUS** toggles the selection of the relay.

A selected relay (K1 and K2 in this example) is displayed with a green surrounding. All selected relays are taken over into a path configuration.

A non selected relay is not considered when defining a path configuration.

The operation as described above applies to the following options of the R&S OSP with similar relay configuration.

Option	Relay configuration
R&S OSP-B123	6 x SPDT relay, 18 GHz, terminated 1 x SP6T relay, 18 GHz, terminated
R&S OSP-B124	3 x SPDT relay, 18 GHz, terminated 3 x SP6T relay, 18 GHz, terminated
R&S OSP-B126	3 x SP6T relay, 18 GHz, terminated
R&S OSP-B129	1 x SP8T relay, 18 GHz, terminated 2 x SPDT relay, 18 GHz

Please note that for the modules R&S OSP-B121 to R&S OSP-B126 and R&S OSP-B129 all relay types SPDT are counted starting with K1 whereas the SP6T types are counted from K11 onwards.

5.3.11 Path Configuration

A very comfortable way to define the different switching paths required in a test setup or in a system is the R&S OSP feature “path configuration”. With suitable dialogs it is easy to combine several relay positions of different R&S OSP modules in one path information. If path switching is required, only the path configuration is called by its name and the switching is performed more or less by a single command.

See also chapter 3.4 for another approach to path configurations using OSP Panel.

In this chapter the functions related to path configurations are described based on some example. Refer to the previous chapters for selecting switch positions or output channel values.

Choosing a default selection



To obtain the correct switching for a new path configuration, it is recommended to start with a well-defined default selection. There are two possibilities described in the following paragraph.

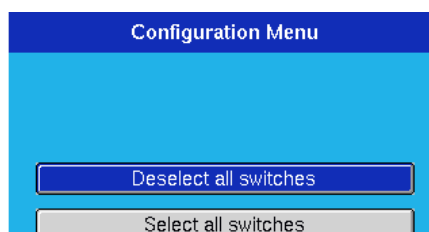

Go from the Main menu to the Configuration menu.

If the number of switches to be included in a path is rather small, it is recommended to deselect all switches. This is done by choosing “Deselect all switches”.

If the number of switches is rather large, chose “Select all switches” instead. Pressing the key **OK** will perform the related action.

Now go back to the Main menu, and from there select “Manual Switching”. In the following steps define all relay and output channel settings you want to include in the path configuration by using the **FUNCTION** key. Don't forget to select these relays and channels using the **STATUS** key if you have started from a deselected switches configuration, or to deselect the ones not required if you have started from a selected switches configuration.

A path configuration may consist out of several relays located on different R&S OSP modules. Please note that the relay buttons in the corresponding dialogs must be selected for all relays which should be taken over in the path configuration.

Perform the settings of the R&S OSP-B101 module as shown in the second screenshot in chapter 5.3.4. This selects K11 to be in NO and K15 to be in NC position.

Then go back to the Main menu using the **MENU** key, and select the Path Switching menu.

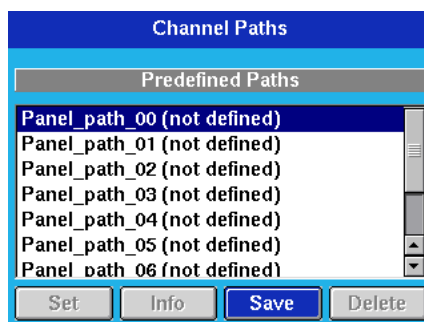

If no path has been saved so far, the list shown in the dialog only contains undefined paths. By default, on an R&S OSP130 there are ten paths which can be defined (Panel_path_00 till Panel_path_09).

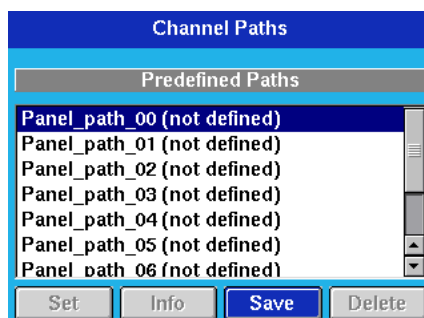

If no path has been saved so far, the list shown in the dialog only contains undefined paths. By default, on an R&S OSP130 there are ten paths which can be defined (Panel_path_00 till Panel_path_09).

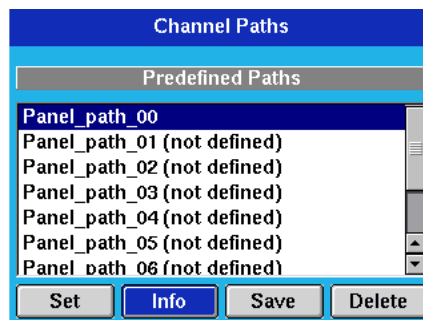

After pressing the **OK** key (Save being the only possibility when an undefined path is marked) the path configuration is stored as Panel_path_00.

Now mark the Info button using the cursor keys and press **OK**.

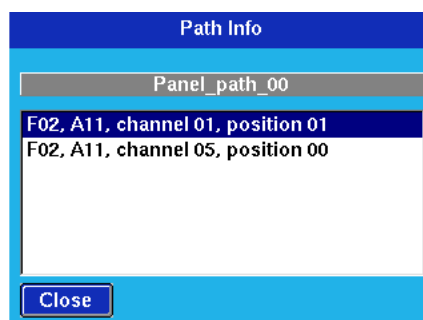

The information displayed thereupon contains the two relays included in the path configuration.

Then go back to Manual switching and select the module R&S OSP-B102. Perform the settings of the R&S OSP-B102 module as shown in the second screenshot in chapter 5.3.5. This selects K1 to be in position 3.

Go now back to the Main menu using the **MENU** key, and select the Path Switching menu.

Channel numbers



Note that for some modules there might be an offset to be included either way in order to convert channel numbers to relay names. For example, channel 1 on an R&S OSP-B101 corresponds to K11.

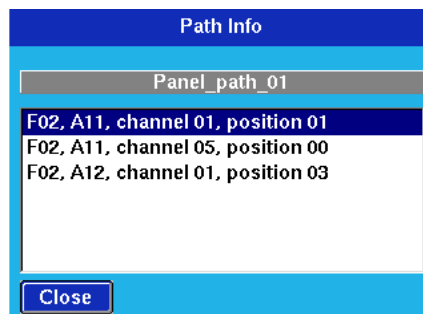

Mark Panel_path_01 with the cursor keys and press **OK**. This saves the configuration. Displaying then the related information will lead to the display shown here. Note that the K1 setting of the R&S OSP-B102 has been added to the previous one

since there was no deselect made for R&S OSP-B101.

Then go back to Manual switching and select the module R&S OSP-B103.

Perform the settings of the R&S OSP-B103 module as shown in the second screenshot in chapter 5.3.6. This selects channel 6 to be low and channel 7 to be high.

Save this configuration in a similar way to Panel_path_02 and display the related information.

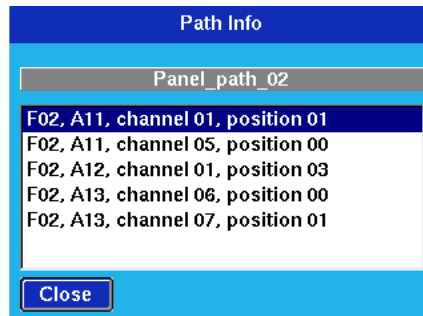

Again, you observe that the new information has been added.

If a new configuration needs to be independent from the previous one, you should use the Configuration menu first in order to deselect or select all switches.

In any case, it is good practice to verify the settings by close inspection of the saved path configuration.

Besides the possibilities for defining a path configuration and to display the information related to this configuration, there are two more actions one can do from the path menu.

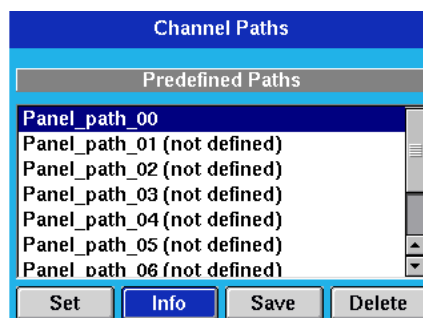

When marking an existing path and choosing the Set button, pressing **OK** will switch all relays and channels related to this path configuration.

Note that performing the switching will not change which switches are selected. Only the state of the switches of the path configuration will be set as desired.

When marking an existing path and choosing the Delete button, pressing **OK** will remove this path.

Names of path configurations



As seen in this chapter, the paths which can be chosen for saving path configurations are the fixed ones (Panel_path_01 etc.) provided on the GUI.

Using the OSP Panel, see chapter 3.4, free names can be given to configurations.

Within the GUI it is possible to save new configurations onto these names as well, and also the other functions like Info, Delete and Set are available.

5.4 R&S OSP Switch Cycle Counter

The R&S OSP is designed with a switch cycle counter.

Although the mechanical relays used in the R&S OSP modules are selected with respect to high life time, it is recommended to count the switching cycles to have an overview on the instrument use and to replace the relays in time. Please note that the Switch Cycle Counter function is disabled for all solid state relays.



R&S OSP Switch Cycle Counter

The cycle counter is active for all R&S OSP modules with mechanical relays. For R&S OSP modules with solid state relays the switch cycle counter is not activated.

The information on the switching cycles is stored on each of the R&S OSP modules. This way the modules always keep the actual information even when exchanging a module.



R&S OSP Switch Cycle Counter

The cycle counter state is not continuously saved on the flash memory of the R&S OSP modules but only in regular intervals. The switch cycle counter only is foreseen to be read for maintenance and service purpose.

The Switch Cycle Counter State can be read using the OSP Panel application.

Operating the OSP Panel will show a button "Fetch Counters" for all R&S OSP modules where this function is applicable. See the following example for R&S OSP-B101 module:

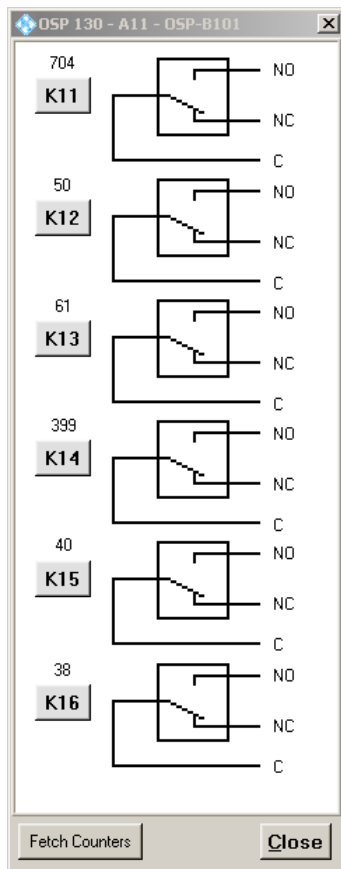

The numbers at each relay label (K11 to K16) show the cycles, the relays already have been switched to NO and NC position, respectively.

Fetch Counters

Selecting this button will read the actual state of the switch cycle counter.

Close

Pressing this button will exit the dialog.

R&S OSP Switch Cycle Counter



Note that the R&S OSP switch cycle counter state is stored on the corresponding switch module on-board memory. To reduce the write operations for the on-board memory, the cycles are stored on the following events:

- each 60 minutes
- every 1000 cycles
- on each "Fetch Counters" command (only if counter state has changed)

5.5 R&S OSP Selftest

The R&S OSP provides a basic selftest procedure on module level. The selftest is primarily intended for production and service purposes; it is not needed during normal operation of the instrument. The following description serves as a general overview.

5.5.1 Selftest via OSP Panel

A selftest can be performed for the R&S OSP via the OSP Panel. See chapter 3 for information on the installation and operation of the OSP Panel application.

The selftest result reflects the current instrument status and checks if all the hardware as shown in OSP Panel module catalog is correctly initialized.

The selftest does not execute special hardware tests.

The selftest is started as follows:

- ▶ Select **>Utility >Self Test ...** in the OSP Panel.

The selftest is started immediately and with positive result, the following message will appear:



Press OK to exit the Selftest Utility.

5.6 R&S OSP Configuration Check

The R&S OSP and the installed modules all are equipped with on-board memory containing the actual device and module data. These data are primarily intended for production and service purposes.

5.6.1 System Info via OSP Panel

The system information can be read out of the R&S OSP via the OSP Panel. See chapter 3 for information on the installation and operation of the OSP Panel application.

The system info can be read as follows:

- ▶ Select **>File >System Info ...** in the OSP Panel.

The system information is read from the R&S OSP hardware and the following text file is opened and displayed:

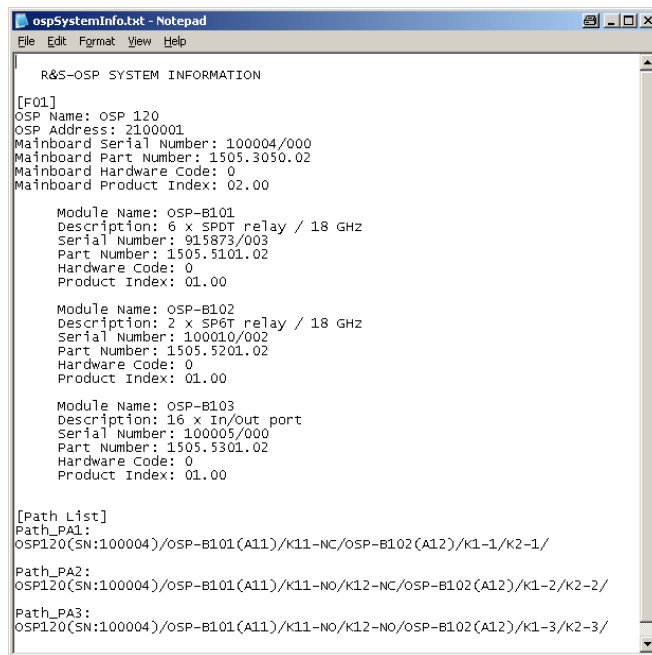

```

ospSystemInfo.txt - Notepad
File Edit Format View Help

R&S-OSP SYSTEM INFORMATION

[F01]
OSP Name: OSP 120
OSP Address: 2100001
Mainboard Serial Number: 100004/000
Mainboard Part Number: 1505.3050.02
Mainboard Hardware Code: 0
Mainboard Product Index: 02.00

Module Name: OSP-B101
Description: 6 x SPDT relay / 18 GHz
Serial Number: 915873/003
Part Number: 1505.5101.02
Hardware Code: 0
Product Index: 01.00

Module Name: OSP-B102
Description: 2 x SP6T relay / 18 GHz
Serial Number: 100010/002
Part Number: 1505.5201.02
Hardware Code: 0
Product Index: 01.00

Module Name: OSP-B103
Description: 16 x In/Out port
Serial Number: 100005/000
Part Number: 1505.5301.02
Hardware Code: 0
Product Index: 01.00

[Path List]
Path_PA1:
OSP120(SN:100004)/OSP-B101(A11)/K11-NC/OSP-B102(A12)/K1-1/K2-1/

Path_PA2:
OSP120(SN:100004)/OSP-B101(A11)/K11-NO/K12-NC/OSP-B102(A12)/K1-2/K2-2/

Path_PA3:
OSP120(SN:100004)/OSP-B101(A11)/K11-NO/K12-NO/OSP-B102(A12)/K1-3/K2-3/

```

If any paths are defined for the R&S OSP, they are listed under [Path List]. The name of the path is indicated together with the relay setting related to the path. Close the Notepad to exit the system info utility.

System Info:



The text file containing the System information is stored with the file name `ospSystemInfo.txt` in the installation directory of the OSP Panel (default directory: `C:\OSP Panel`).

Each time the system info utility is started at the OSP Panel, this file is overwritten with the actual data.

5.7 SCPI Read/Write

As an additional feature, the OSP Panel allows a direct communication with the R&S OSP via SCPI commands. This additional feature is foreseen for debug purpose and requires to be familiar with SCPI commands of the R&S OSP. Refer to the section on remote control (chapters 6 and 7 of the operating manual) for further information.

For direct communication with the R&S OSP via LAN interface proceed as follows:

1. Start the OSP Panel.
2. Select **>Utility >Read/Write ...** in the OSP Panel.

The following dialog will appear:

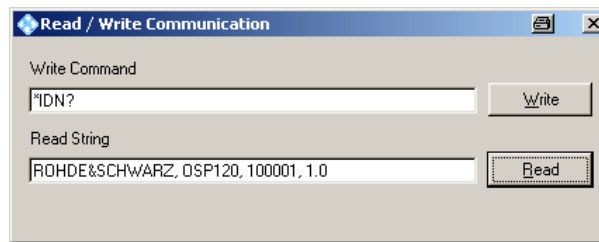

The command to be written to the R&S OSP is entered in the upper text field. The above example sends the identify command to the R&S OSP as soon as the Write button is pressed.

After pressing the Read button, the answer is read from the R&S OSP. In the above example the identification of the R&S OSP is read back and displayed.



Having entered the SCPI command in the text field next to this button, the command is sent to the R&S OSP as soon as this button is pressed.



If the command sent to the R&S OSP is a query command expecting an answer from the R&S OSP, the answer can be read by pressing the READ button.

SCPI Read/Write Commands



This function is not required for operation of the R&S OSP. It is foreseen as additional feature for test and debug purpose. The use of SCPI Read/Write Commands requires knowledge of the R&S OSP remote control commands.

5.7.1 R&S OSP Temperature Read command

The R&S OSP design with I²C interface and memory on each module has the utility to read the temperature on it's interface.

Read R&S OSP module temperature



Note that this utility makes use of the module interface function. The read-back of the module temperature is just for information and is not specified. This utility may be used for example to examine the temperature conditions of the R&S OSP when the unit is operated inside a rack.

The read the temperature from the R&S OSP modules, the following SCPI command is sent to the R&S OSP: `diag:service:sfun? F01,"temp2 0"`

F01 is the R&S OSP frame 1 and temp2 the command to read the temperature.

The last digit in the above string has the following meaning:

- 0 = R&S OSP Mainboard
- 1 = R&S OSP Module interface 1
- 2 = R&S OSP Module interface 2
- 3 = R&S OSP Module interface 3

The SCPI command can be sent via the application OSP Panel, >Utility >Read/Write as shown in the below example.

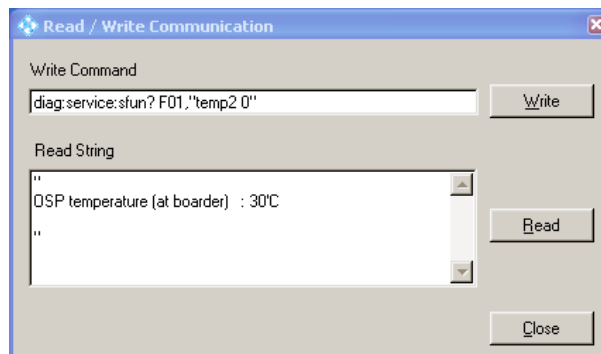

Note that for the above function the corresponding module must be configured in the R&S OSP; if the module interface is not available, an error message will appear.

6 Index

AC fuse board.....	22	Keyboard.....	24
AC power.....	22	Keys	
AC supply.....	22	back.....	16
BACK.....	16	cursors.....	16
Bench top operation.....	21	function.....	16
CAN bus connector.....	19	home.....	16
CLK.....	14	local.....	16
Configuring/connecting OSP Panel.....	36	menu.....	16
Connecting a monitor.....	25	off.....	16
Connecting R&S OSP120 and PC.....	34	OK.....	16
Controlling the OSP-B108.....	53	on.....	16
Controlling the OSP-B112.....	46	reset.....	16
Controlling the OSP-B131.....	54	standby.....	14
Controlling the R&S OSP-B102.....	46	status.....	16
Controlling the R&S OSP-B103.....	47	LAN.....	14
Controlling the R&S OSP-B104.....	49	cable.....	25
Controlling the R&S OSP-B108.....	53	connection.....	25
Controlling the R&S OSP-B114.....	49	DHCP.....	26
Controlling the R&S OSP-B116.....	54	remote operation.....	26
Controlling the R&S OSP-B131.....	54	LAN connector.....	18
Controlling the R&S OSP-B136.....	54	Mains connector.....	19
Controlling the R&S OSP-B142.....	55	Mains switch.....	19
Controlling the R&S OSP-B158.....	47	Maintenance.....	23
Cursor.....	16	Manual operation of the modules.....	68
DC MUX module R&S OSP-B108.....	87	MENU.....	16
Delete a path.....	59	Module functions.....	78
EMI.....	21	Monitor connector.....	15
Equipment supplied.....	20	OK.....	16
Example path configuration.....	63	OSP application.....	26
Export a path.....	60	OSP Panel.....	29
External accessories.....	24	OSP Panel functions.....	36
Firmware update.....	31, 32	Power on/off.....	22
Front panel.....	13	Power Sensor Module R&S OSP-PM-I.....	99
FUNCTION.....	16	Preparing for use.....	13
Fuses.....	22	PWR.....	14
replacing.....	22	R&S OSP block diagram.....	70
General navigation operations.....	106	R&S OSP configuration check.....	122
Getting started.....	34	R&S OSP Instrument frame.....	69
graphical user interface.....	104	R&S OSP module slots.....	72, 73, 74, 75, 77, 78
HOME.....	16	R&S OSP selftest.....	122
I/O and supply Module R&S OSP-B158.....	102	R&S OSP setups.....	68
I/O module R&S OSP-B103.....	81	R&S OSP switch cycle counter.....	120
I/O module R&S OSP-B104.....	83	Rack (mounting).....	21
I/O module R&S OSP-B106.....	85	Rack Adapter ZZA-96.....	21
I/O module R&S OSP-B132.....	85	Replacing	
Import a path.....	62	AC fuse board.....	22
Indicator		fuses.....	22
LED.....	14, 23	RESET key.....	16
status.....	16	RF switch module OSP-B102.....	79
Installing OSP Panel.....	35	RF switch module OSP-B112.....	79
Instrument		RF switch module OSP-B128.....	79
connecting.....	22	RF switch module R&S OSP-B101.....	78
unpacking.....	20	RF Switch Module R&S OSP-B101L.....	101
Instrument setup.....	20	RF Switch Module R&S OSP-B102L.....	101
IP address.....	26	RF switch module R&S OSP-B107.....	78
assign.....	26	RF switch module R&S OSP-B111.....	78

RF Switch Module R&S OSP-B116.....	100	Starting the R&S OSP130.....	106
RF Switch Module R&S OSP-B119.....	97	Startup procedure.....	26
RF Switch Module R&S OSP-B123.....	90	STATUS.....	16
RF Switch Module R&S OSP-B124.....	90	Storing the instrument.....	24
RF switch module R&S OSP-B127.....	78	Switch a path.....	59
RF Switch Module R&S OSP-B129.....	97	System info via OSP Panel.....	122
RF Switch Module R&S OSP-B136.....	100	TCP/IP.....	26
RF Switch Module R&S OSP-B142.....	103	Unpacking.....	20
Sample session.....	63	USB connector.....	14, 17
Save a path.....	57	USB flash drive.....	24
Selftest via OSP Panel.....	122	Using the R&S OSP-B101.....	109
Setup file.....	31	Using the R&S OSP-B102.....	110
Shipment, check.....	20	Using the R&S OSP-B103.....	111
Shut down.....	26	Using the R&S OSP-B104.....	112
Software update.....	31, 32	Using the R&S OSP-B106.....	109
Standby.....	14, 22, 23	Using the R&S OSP-B107.....	109
key.....	14	Using the R&S OSP-B111.....	109
Starting the R&S OSP120.....	105	Using the R&S OSP-B112.....	110